

# HOHAGE

Wir biegen Lösungen

## Warenträger • Dekorationsartikel

Goods holder • Means of sale and decoration

Portamateriales • Productos de decoración

Supports de marchandises • Produits de décoration



### C. Hohage GmbH & Co KG

Rahmedestraße 406-408

D-58762 Altena

Tel. +49 (0) 23 52 543 0

Fax +49 (0) 23 52 543 10

E-Mail [info@hohage.de](mailto:info@hohage.de)

[www.hohage.de](http://www.hohage.de)



**HOHAGE** - seit über 150 Jahren Ihr leistungsfähiger Partner  
Unsere Erfahrung und Innovationskraft sichert Ihren Erfolg!  
Wir biegen Lösungen! - Sprechen Sie uns an.

**HOHAGE** - for more than 150 years now your efficient business partner  
Our know-how and innovative capacity ensure your success!  
We bend solutions! Please do not hesitate to ask us.

**HOHAGE** - Desde hace 150 años su colaborador más eficaz  
Nuestra experiencia y capacidad de innovación, aseguran su éxito!  
Ofrecemos Soluciones! Contacte con nosotros.

**HOHAGE** - votre partenaire puissant depuis plus de 150 années  
Notre connaissance et notre force d'innovation assurent votre réussite!  
Comme le fil que nous travaillons, nous "recourbons" les solutions!



#### Artikel für Lochwand mit Lochabstand 15 mm

Articles for pegboard with hole spacing 15 mm  
Artículos para fondo perforado, distancia agujeros 15 mm  
Articles pour fond perforé, entraxe 15 mm



#### Artikel für Lochwand mit Lochabstand 25 mm

Articles for pegboard with hole spacing 25 mm  
Artículos para fondo perforado, distancia agujeros 25 mm  
Articles pour fond perforé, entraxe 25 mm

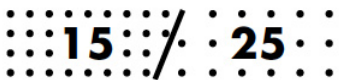

#### Artikel für Lochwand mit Lochabstand 15 oder 25 mm

Articles for pegboard with hole spacing 15 or 25 mm  
Artículos para fondo perforado, distancia agujeros 15 ó 25 mm  
Articles pour fond perforé, entraxe 15 ou 25 mm



#### Artikel für Lochwand mit Schlüssellochung

Articles for pegboard with combined round and key holes  
Artículos para paneles traseros perforados llave  
Articles pour fond à perforation clés

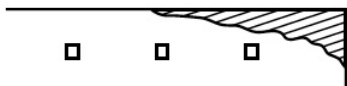

#### Artikel für geschlitzte Metall-, Hartfaser- und Pappwände

Articles for slotted metal, hard masonite or cardboard panels  
Artículos para panel ranurado metalico, aglomerado ó cartón  
Articles pour panneaux rainurés de métal, d'isorel dur ou de carton

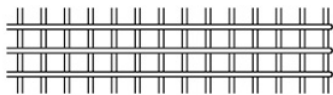

#### Artikel für Gitterwand

Articles for grid wall  
Artículos para rejilla  
Articles pour dos grillagé

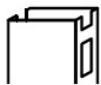

#### Artikel für Regalsäule mit 50er Schlitzung

Articles for column with 50 mm slot  
Artículos para columnas con perforación de 50 mm  
Articles pour colonne avec échancrure 50 mm



#### Artikel für Rechteckrohr (gelocht und ungelocht)

Articles for rectangular tube (with and without holes)  
Artículos para tubo cuadrado (con ó sin perforaciones)  
Articles pour tube rectangulaire (avec ou sans trous)

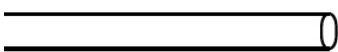

#### Artikel für Flachovalrohr

Articles for flat oval tube  
Artículos para barra oval  
Articles pour tube oval



#### Artikel für Lamellenwand

Articles for slatwall  
Artículos para panel de lamas  
Articles pour fond à lamelle



### Drahtdurchmesser

Wire diameter  
Diámetro del alambre  
Diamètre de fil

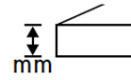

### für Stärke

for thickness  
para espesor  
pour épaisseur

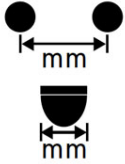

### Einhängebreite

Spacing Largo de suspension  
Largeur de suspension



### Durchmesser

Diameter  
Diámetro  
Diamètre

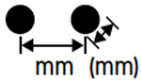

### Einhängebreite und Durchmesser der Eihängung

Wire diameter  
Diámetro del alambre  
Diamètre de fil

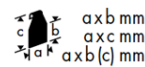

### Maße Etikettenfahne

Dimensions of price flag  
Medida etiqueta  
Dimensions d'étiquette

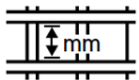

### Gitterabstand

Grid mesh  
Distancia rejilla  
Distance grille



### Maße Ovalschiene

Dimensions of oval bar  
Medida barra oval  
Dimensions de barre ovale

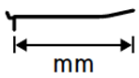

### Länge

Length  
Longitud  
Longueur



### Zugkraft

Load capacity  
Fuerza de sustentación  
Capacité de charge

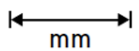

### Breite

Width  
Anchura  
Largeur



### Höhe

Height  
Altura  
Hauteur



### Verpackungseinheit

Packing unit  
Unidad de embalaje  
Unité d'emballage



### Tiefe

Depth  
Profundidad  
Profondeur



### Gewicht je 100 Stück

Weight per 100 pieces  
Peso por 100 unidades  
Poids par 100 pièces



### Hakenfarbe weiß / schwarz

Colour of hooks white / black  
Color de ganchos blanco / negro  
Couleur de crochets blanc / noir

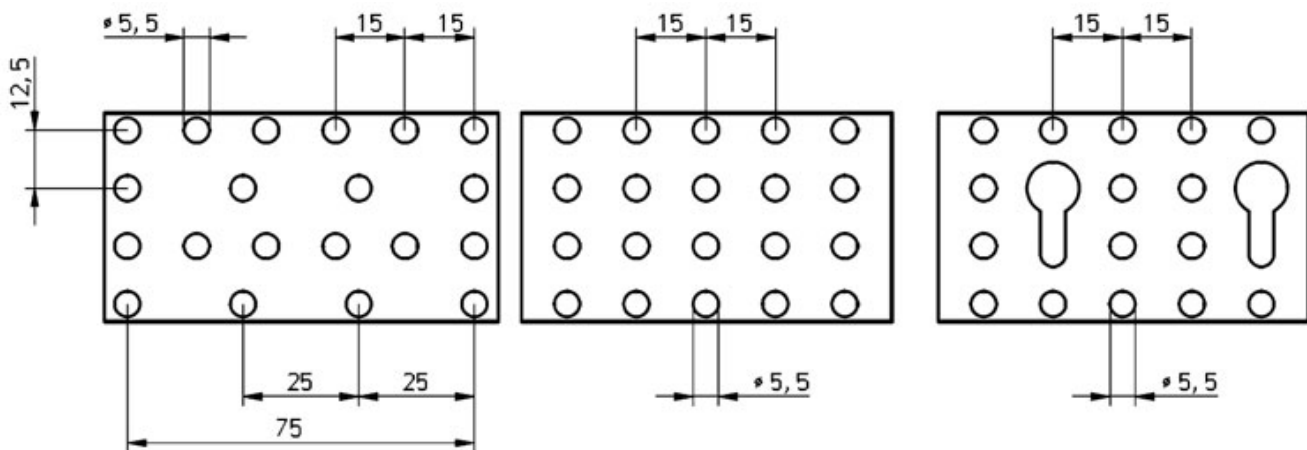
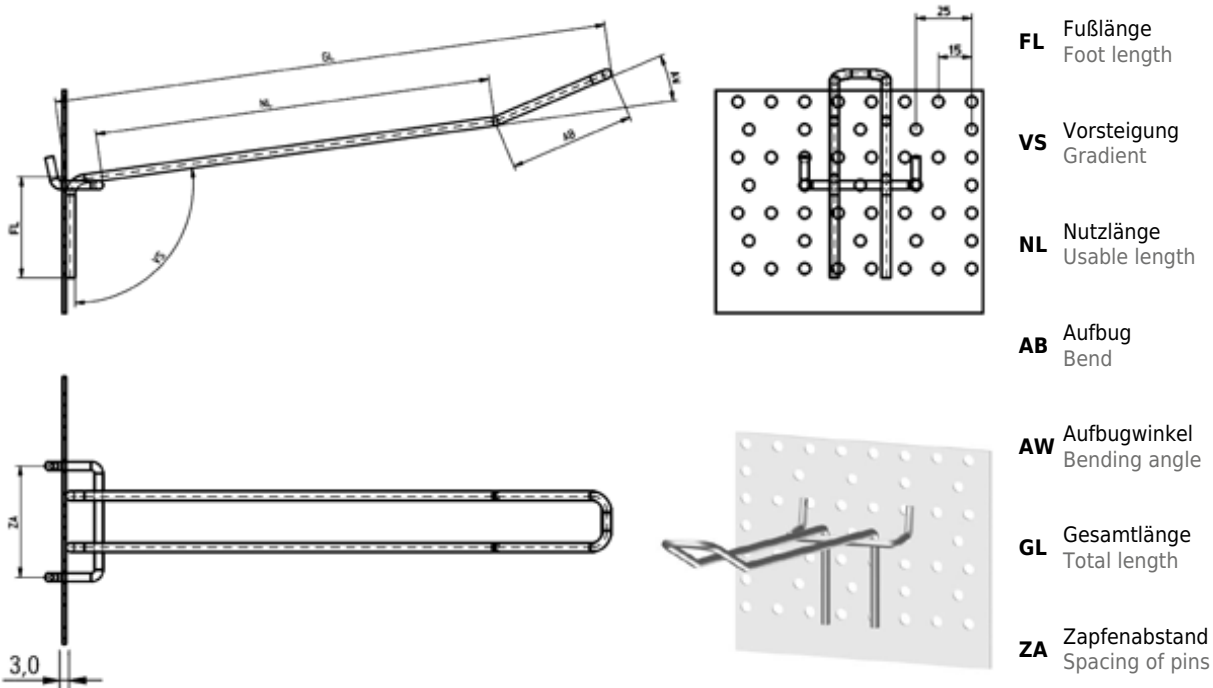

**Eurolochung/Rundloch**  
„Euro“-perforation/Round holes

**Normloch**  
Standard perforation

**Schlüsselochung**  
Combined round and key holes

**Rechteckrohr** H(x) x B (y) (z. B. 50 x 20, 40 x 20 mm)  
Rectangular tube

**Flachovalrohr** H(x) x B (y) (z. B. 50 x 20, 30 x 15 mm)  
Flat oval tube

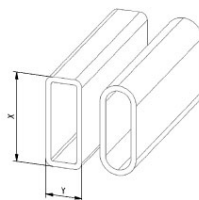

**Regalsäule / Column**  
Rastermaß (A), Steghöhe (B) und Einhänghöhe (C)  
Spacing (A), Base height (B) and Hanging height (C)

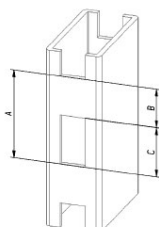

## Inhaltsverzeichnis

Contents • Contenido • Table des matières

### Allgemeine Hinweise

General information  
Informaciones generales  
Information générale

<b>1</b>	<b>Einfach- und Doppelhaken</b> Single and double hooks Ganchos simples y dobles Broches simples et doubles	<b>9 - 18</b>
----------	--	---------------

<b>2</b>	<b>Systemhaken mit Schnellbefestigung</b> Fast entry hooks Ganchos con cierre giratorio Crochets à système	<b>19 - 26</b>
----------	---	----------------

<b>3</b>	<b>Systemhaken mit Preisauszeichnung / Zubehör</b> System hooks with price labelling / Accessories Ganchos con portaprecios / Accesorios Crochets à système avec affichage du prix / Accessoires	<b>27 - 38</b>
----------	---	----------------

<b>4</b>	<b>Haken für Trageschiene</b> Hooks for bar systems Ganchos para sistema de barra Crochets pour barres	<b>39 - 50</b>
----------	---	----------------

<b>5</b>	<b>Sonderhaken Werkzeuge</b> Special hooks for tools Ganchos especiales para herramientas Crochets spéciaux pour outils	<b>51 - 60</b>
----------	--	----------------

<b>6</b>	<b>Gitterwandhaken</b> Hooks for grid wall Ganchos para rejillas Crochets pour fond grillagé	<b>61 - 66</b>
----------	---	----------------

<b>7</b>	<b>Lamellenwandhaken</b> Slatwall hooks Ganchos para panel de lamas Crochets pour fond lame	<b>67 - 72</b>
----------	--	----------------

<b>8</b>	<b>Chromprogramm</b> Chromium-plated products Productos cromados Produits chromés	<b>73 - 82</b>
----------	--	----------------

<b>9</b>	<b>Specials</b> Special means of presentation Presentaciones especiales Produits spéciaux de présentation	<b>83 - 94</b>
----------	--	----------------

<b>10</b>	<b>Abhänge- und Auszeichnungssysteme</b> Means of sale and decoration Productos de decoración Produits de décoration	<b>95 - 119</b>
-----------	---	-----------------

## Informaciones generales sobre el catálogo y el envío

- Todos los precios se encuentran en nuestra lista de precios, que se halla en hoja aparte. Nuestros precios son en euro, a los que debe agregarse el impuesto sobre el valor añadido.
- Los costes de embalaje y de envío se cargarán como precio e coste.
- Nuestros envíos se basan en nuestras condiciones generales de negocios que pueden ser vistas en [www.hohage.de](http://www.hohage.de) o pueden ser consultadas en la lista de precios.
- A los envíos de un valor neto menor a € 50,00 le cargaremos un suplemento de € 10,00.
- Los precios son de fábrica Altena y no incluyen el embalaje.
- El pago se debe realizar a 10 días menos el 2 % de descuento, o neto a 30 días.
- Puede llegar a haber diferencias entre la mercancía entregada y la que figura en el catálogo. Nos reservamos el derecho a realizar modificaciones a o errores.
- Encontrará su persona de contacto y más información en [www.hohage.de](http://www.hohage.de).
- En varios países europeos, en el caso de los ganchos simples, existe la obligación de asegurar el extremo puntiagudo.

## Information Générale de Catalogue

- Pour les prix veuillez vous référer au tarif séparé. Nos prix s'entendent en euros, sans taxe sur la valeur ajoutée.
- Nous facturerons les frais occasionnés par l'emballage et l'expédition à nos propres prix de revient. Ils seront alors à la charge de l'acheteur.
- La livraison sera effectuée sur la base de nos conditions générales qui sont indiquées dans le prix-tarif ainsi que sur [www.hohage.de](http://www.hohage.de).
- Pour des commandes d'une valeur inférieure à 50,00 euros, nous facturerons un supplément de 10,00 euros.
- Les prix s'entendent ex usine Altena, sans emballage.
- Le paiement est à effectuer dans les 10 jours déduction faite de 2% ou dans les 30 jours net.
- Nous réservons le droit de livrer des produits qui diffèrent légèrement des produits indiqués dans le catalogue.
- Vous trouverez le nom de votre personne à contacter ainsi que de plus amples informations à notre site sur Internet [www.hohage.de](http://www.hohage.de).
- Dans différents pays européens, il existe l'obligation de sécuriser l'extrémité pointue des crochets simples



## Allgemeine Katalog- und Lieferungsinformationen

- Alle Preise finden Sie in unserer separaten Preisliste. Unsere Preise sind in Euro zzgl. der gesetzlichen Mehrwertsteuer, bei Auslandslieferungen ohne Mehrwertsteuer.
- Verpackungs- und Versandkosten werden zum Selbstkostenpreis berechnet.
- Unseren Lieferungen liegen unsere allgemeinen Geschäftsbedingungen zugrunde, die Sie im Internet unter [www.hohage.de](http://www.hohage.de) abrufen oder der Preisliste entnehmen können.
- Für Lieferungen unter einem Nettowarenwert von € 50,00 berechnen wir einen Mindermengenzuschlag von € 10,00.
- Die Preise verstehen sich ab Werk Altena, exklusive der Verpackung.
- Die Zahlung hat innerhalb von 10 Tagen abzüglich 2 % Skonto oder innerhalb von 30 Tagen netto zu erfolgen.
- Es kann zu Abweichungen zwischen der gelieferten und der im Katalog abgebildeten Ware kommen. Änderungen oder Irrtümer behalten wir uns vor.
- Ihre Ansprechpartner und weitere Informationen finden Sie unter [www.hohage.de](http://www.hohage.de).
- In diversen europäischen Ländern besteht bei Einzelhaken eine Verpflichtung zur Sicherung der spitzen Enden.

## General Catalogue Information

- All prices are shown in our separate price list. Our prices are quoted in euro exclusive VAT.
- Packing and transport will be charged at cost.
- Our deliveries are subject to our general terms and conditions which can be taken from the price list or the internet at [www.hohage.de](http://www.hohage.de).
- For deliveries with a net goods value below € 50.00, an additional fee of €10.00 will be charged.
- The prices are quoted ex works Altena, exclusive packing.
- Payment is to be made within 10 days less 2% or within 30 days net.
- The goods delivered are subject to variation. Errors and omissions excepted.
- You will find the name of your contact person and further information at [www.hohage.de](http://www.hohage.de).
- In diverse European countries there is an obligation to safeguard the pointed ends on single hooks.

# HOHAGE

---

Wir biegen Lösungen



# HOHAGE

---

Wir biegen Lösungen

1

## **Einfach- und Doppelhaken**

Single and double hooks  
Ganchos simples y dobles  
Broches simples et doubles

## Lochwandhaken verzinkt

Single hook zinc

Gancho simple zincado

Crochet simple zingué

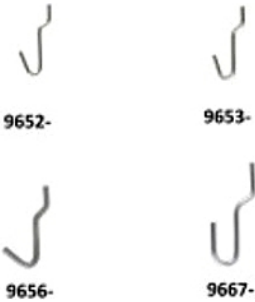

15 / 25			mm	mm		kg
9652-020035A			2,0	35	100	0,1
9653-025035A			2,5	35	100	0,3
9656-034040A			3,4	40	100	0,4
9667-034050A			3,4	50	100	0,6

## Lochhaken verzinkt

Ceiling anchor hook zinc

Gancho techo zincado

Crochet accrochage à plafond zingué

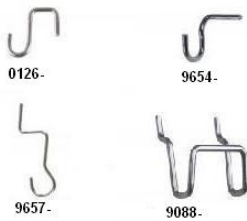

15 / 25			mm	mm		kg
9657-020045A			2,0	45	100	0,2
9654-025024A			2,5	24	100	0,3
0126-030025A			3,0	25	100	0,4
9088-025030A			2,5	30	100	0,6

## Schlaufenhaken ca. 10 Grad Vorsteigung, verzinkt

Double loop hook gradient approx. 10 degrees, zinc

Gancho doble para fondo perforado angulo aprox. 10 grados, zincado

Broche double en forme de boucle pente environ 10 degrés, zingué



15 / 25	mm		mm	mm		kg
9688-025040A	25/30		2,5	40	50	0,6
9688-025060A	25/30		2,5	60	25	0,4
9688-025080A	25/30		2,5	80	25	1,0
9688-025100A	25/30		2,5	100	25	1,2

## Schlaufenhaken ca. 10 Grad Vorsteigung, verzinkt

Double loop hook gradient approx. 10 degrees, zinc

Gancho doble para fondo perforado angulo aprox. 10 grados, zincado

Broche double en forme de boucle pente environ 10 degrés, zingué



15 / 25	mm		mm	mm		kg
9688-030100A	25/30		3,0	100	25	1,7
9688-030120A	25/30		3,0	120	25	1,9
9688-030140A	25/30		3,0	140	50	2,1
9688-030160A	25/30		3,0	160	50	2,3
9688-030180A	25/30		3,0	180	50	2,5
9688-030200A	25/30		3,0	200	50	2,7

## Schlaufenhaken ca. 10 Grad Vorsteigung, verzinkt

**Double loop hook** gradient approx. 10 degrees, zinc

**Gancho doble fondo perforado** angulo aprox. 10 grados, zincado

**Broche double en forme de boucle** pente environ 10 degrés, zinguée

15°/25°	mm	mm	mm	mm	mm	kg	
9688-034100A	25/30			3,4	100	25	2,5
9688-034120A	25/30			3,4	120	25	2,7
9688-034140A	25/30			3,4	140	50	2,5
9688-034160A	25/30			3,4	160	50	3,1
9688-034200A	25/30			3,4	200	50	3,5



## Schlaufenhaken ca. 10 Grad Vorsteigung, verzinkt

**Double loop hook** gradient approx. 10 degrees, zinc

**Gancho doble para fondo perforado** angulo aprox. 10 grados, zincado

**Broche double en forme de boucle** pente environ 10 degrés, zinguée

15°/25°	mm	mm	mm	mm	mm	kg	
9688-038200A	25/30			3,8	200	50	4,5
9688-038250A	25/30			3,8	250	50	5,4
9688-038275A	25/30			3,8	275	50	5,9
9688-038300A	25/30			3,8	300	50	6,3



## Schlaufenhaken ca. 15 Grad Vorsteigung, verzinkt

**Double loop hook** gradient approx. 15 degrees, zinc

**Gancho doble para fondo perforado** angulo aprox. 15 grados, zincado

**Broche double en forme de boucle** pente environ 15 degrés, zinguée

15°/25°	mm	mm	mm	mm	mm	kg	
9689-038200A	25/30			3,8	200	50	4,5
9689-038275A	25/30			3,8	275	50	5,8
9689-038340A	25/30			3,8	340	50	6,9
9689-038370A	25/30			3,8	370	50	7,3



## Schlaufenhaken ca. 15 Grad Vorsteigung, verzinkt

**Double loop hook** gradient approx. 15 degrees, zinc

**Gancho doble para fondo perforado** angulo aprox. 15 grados, zincado

**Broche double en forme de boucle** pente environ 15 degrés, zinguée

15°/25°	mm	mm	mm	mm	mm	kg	
9689-040300A	25/30			4,0	300	50	6,4
9689-040340A	25/30			4,0	340	50	7,3
9689-040370A	25/30			4,0	370	50	8,2
9689-040400A	25/30			4,0	400	50	9,1



## Einfachhaken verzinkt

Single hook zinc

Gancho simple zincado

Crochet simple zingué



15		mm (mm)	mm	mm		kg
9781-034060A		15(3,4)	3,4	60	50	1,2
9781-034080A		15(3,4)	3,4	80	50	1,3
9781-034100A		15(3,4)	3,4	100	50	1,4
9781-034120A		15(3,4)	3,4	120	50	1,6
9781-034160A		15(3,4)	3,4	160	50	1,8
9781-034200A		15(3,4)	3,4	200	50	2,1

## Einfachhaken verzinkt

Single hook zinc

Gancho simple zincado

Crochet simple zingué



15		mm (mm)	mm	mm		kg
9781-048120A		15(3,4)	4,8	120	50	2,7
9781-048160A		15(3,4)	4,8	160	50	3,7
9781-048200A		15(3,4)	4,8	200	50	4,7

## Einfachhaken mit Kugel verzinkt

Single hook with ball tip end zinc

Gancho simple con terminal bola zincado

Crochet simple à bille zingué



15	25	mm (mm)	mm	mm		kg
9773-034045A	9673-034045A	30/25(2,5)	3,4	45	50	0,9
9773-034060A	9673-034060A	30/25(2,5)	3,4	60	50	1,1
9773-034080A	9673-034080A	30/25(2,5)	3,4	80	50	1,3
9773-034100A	9673-034100A	30/25(2,5)	3,4	100	50	1,5
9773-034120A	9673-034120A	30/25(2,5)	3,4	120	50	1,7
9773-034140A	9673-034140A	30/25(2,5)	3,4	140	50	1,9
9773-034160A	9673-034160A	30/25(2,5)	3,4	160	50	2,1
9773-034180A	9673-034180A	30/25(2,5)	3,4	180	50	2,3
9773-034200A	9673-034200A	30/25(2,5)	3,4	200	50	2,5
9773-034220A	9673-034220A	30/25(2,5)	3,4	220	50	2,7

## Einfachhaken mit Kugel verzinkt

Single hook with ball tip end zinc

Gancho simple con terminal bola zincado





Crochet simple à bille zingué



15	25	mm (mm)	mm	mm		kg
9778-034060A	9678-034060A	30/25(3,4)	3,4	60	50	1,2
9778-034080A	9678-034080A	30/25(3,4)	3,4	80	50	1,4
9778-034100A	9678-034100A	30/25(3,4)	3,4	100	50	1,6
9778-034120A	9678-034120A	30/25(3,4)	3,4	120	50	1,8
9778-034140A	9678-034140A	30/25(3,4)	3,4	140	50	2,0
9778-034160A	9678-034160A	30/25(3,4)	3,4	160	50	2,2
9778-034180A	9678-034180A	30/25(3,4)	3,4	180	50	2,4
9778-034200A	9678-034200A	30/25(3,4)	3,4	200	50	2,6
9778-034220A	9678-034220A	30/25(3,4)	3,4	220	50	2,8

## Einfachhaken mit Kugel verzinkt





Single hook with ball tip end zinc  
Gancho simple con terminal bola zincado  
Crochet simple à bille zingué

15	25					
9786-040060A	9686-040060A	30/25(3,4)	4,0	60	50	1,5
9786-040080A	9686-040080A	30/25(3,4)	4,0	80	50	1,7
9786-040100A	9686-040100A	30/25(3,4)	4,0	100	50	1,9
9786-040120A	9686-040120A	30/25(3,4)	4,0	120	50	2,1
9786-040140A	9686-040140A	30/25(3,4)	4,0	140	50	2,3
9786-040160A	9686-040160A	30/25(3,4)	4,0	160	50	2,5
9786-040180A	9686-040180A	30/25(3,4)	4,0	180	50	2,7
9786-040200A	9686-040200A	30/25(3,4)	4,0	200	50	2,9
9786-040220A	9686-040220A	30/25(3,4)	4,0	220	50	3,1



## Einfachhaken verzinkt





Single hook zinc  
Gancho simple zincado  
Crochet simple zingué

15	25					
9340-048150A	9240-048150A	30/25(3,4)	4,8	150	50	3,2
9340-048200A	9240-048200A	30/25(3,4)	4,8	200	50	4,0
9340-048250A	9240-048250A	30/25(3,4)	4,8	250	50	4,7
9340-048300A	9240-048300A	30/25(3,4)	4,8	300	50	5,4
9340-048400A	9240-048400A	30/25(3,4)	4,8	400	50	6,8



## Einfachhaken verzinkt





Single hook zinc  
Gancho simple zincado  
Crochet simple zingué

15	25					
9787-060100A	9687-060100A	45/50(3,8)	6,0	100	50	4,4
9787-060150A	9687-060150A	45/50(3,8)	6,0	150	50	5,5
9787-060200A	9687-060200A	45/50(3,8)	6,0	200	50	6,5
9787-060250A	9687-060250A	45/50(3,8)	6,0	250	50	7,5
9787-060300A	9687-060300A	45/50(3,8)	6,0	300	50	8,5
9787-060350A	9687-060350A	45/50(3,8)	6,0	350	50	9,5
9787-060400A	9687-060400A	45/50(3,8)	6,0	400	50	10,5
9787-060450A	9687-060450A	45/50(3,8)	6,0	450	50	11,5



## Einfachhaken verzinkt

Single hook zinc  
Gancho simple zincado  
Crochet simple zingué







15	25					
9790-080200A	9690-080200A	45/50(3,8)	8,0	200	50	11,8
9790-080300A	9690-080300A	45/50(3,8)	8,0	300	50	14,6
9790-080400A	9690-080400A	45/50(3,8)	8,0	400	50	18,7
9790-080500A	9690-080500A	45/50(3,8)	8,0	500	50	24,8
9791-100300A	9691-100300A	45/50(3,8)	10,0	300	50	22,5
9791-100400A	9691-100400A	45/50(3,8)	10,0	400	50	30,7
9791-100500A	9691-100500A	45/50(3,8)	10,0	500	50	36,2

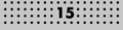
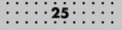

## Doppelhaken verzinkt

**Double hook** zinc  
**Gancho doble** zincado  
**Crochet double** zingué







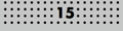
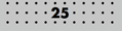

						
9794-034100A	9694-034100A	45/50(2,5)	3,4	100	50	2,5
9794-034150A	9694-034150A	45/50(2,5)	3,4	150	50	3,2
9794-034200A	9694-034200A	45/50(2,5)	3,4	200	50	3,9

## Doppelhaken verzinkt

**Double hook** zinc  
**Gancho doble** zincado  
**Crochet double** zingué







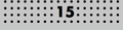
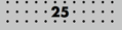

						
9122-034100A	9022-034100A	45/50(3,8)	3,4	100	50	3,0
9122-034150A	9022-034150A	45/50(3,8)	3,4	150	50	3,7
9122-034200A	9022-034200A	45/50(3,8)	3,4	200	50	4,4

## Doppelhaken verzinkt

**Double hook** zinc  
**Gancho doble** zincado  
**Crochet double** zingué







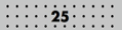

						
9307-040150A	9207-040150A	45/50(3,8)	4,0	150	50	4,8
9307-040200A	9207-040200A	45/50(3,8)	4,0	200	50	5,7
9307-040250A	9207-040250A	45/50(3,8)	4,0	250	50	6,6
9307-040300A	9207-040300A	45/50(3,8)	4,0	300	50	7,5

## Doppelhaken verzinkt

**Double hook** zinc  
**Gancho doble** zincado  
**Crochet double** zingué



						
9304-048200A	9204-048200A	45/50(3,8)	4,8	200	50	7,8
9304-048250A	9204-048250A	45/50(3,8)	4,8	250	50	9,4
9304-048300A	9204-048300A	45/50(3,8)	4,8	300	50	10,0
9304-048400A	9204-048400A	45/50(3,8)	4,8	400	50	12,2



## Doppelhaken verzinkt

Double hook zinc  
Gancho doble zincado  
Crochet double zingué

15	25	mm (mm)	mm	mm	mm	kg
9306-060200A	9206-060200A	45/50(3,8)	6,0	200	50	11,8
9306-060300A	9206-060300A	45/50(3,8)	6,0	300	50	16,3
9306-060400A	9206-060400A	45/50(3,8)	6,0	400	50	20,8

Mindestbestellmenge 1000 Stück je Sorte / minimum order quantity 1000 pieces  
Quantité minimale de commande: 1000 pièces / cantidad mínima por pedido: 1000 unidades



## Schwerlasthaken verzinkt

Triple hook heavy type zinc  
Gancho triple cargas pesadas zincado  
Crochet triple zingué

15	25	mm (mm)	mm	mm	mm	kg
2491582010	2490582010	45/50(3,8)	3,8/6,0	200	50	16,2
2491583010	2490583010	45/50(3,8)	3,8/6,0	300	50	17,3
2491584010	2490584010	45/50(3,8)	3,8/6,0	400	50	23,1
2491585010	2490585010	45/50(3,8)	3,8/6,0	500	50	29,0

Artikel nur auf Anfrage erhältlich / only on request / uniquement sur demande / solamente a pedido



## Schwerlasthaken verzinkt

Triple hook heavy type zinc  
Gancho triple cargas pesadas zincado  
Crochet triple zingué

15	25	mm (mm)	mm	mm	mm	kg
2491593010	2490593010	45/50(3,8)	3,8/8,0	300	50	18,3
2491594010	2490594010	45/50(3,8)	3,8/8,0	400	50	24,1
2491595010	2490595010	45/50(3,8)	3,8/8,0	500	50	30,0

Artikel nur auf Anfrage erhältlich / only on request / uniquement sur demande / solamente a pedido



## Einfachhaken für Lochwand Kunststoff

Single hook for pegboard plastics

Gancho simple para fondo perforado plástico

Crochet simple pour fond perforé plastique



	25	mm	mm	mm			
8125390525	25		5,0	50	RAL9005	50	0,5
8125391025	25		5,0	100	RAL9005	50	0,7
8125391525	25		5,0	150	RAL9005	50	0,9
8125392025	25		5,0	200	RAL9005	50	1,1
8125390515	25		5,0	50	RAL9001	50	0,5
8125391015	25		5,0	100	RAL9001	50	0,7
8125391515	25		5,0	150	RAL9001	50	0,9
8125392015	25		5,0	200	RAL9001	50	1,1

Artikel nur auf Anfrage erhältlich / only on request / uniquement sur demande / solamente a pedido

## Einfachhaken für Papprückwand Kunststoff

Single hook for cardboard displays plastics

Gancho simple para expositor de carton plástico

Crochet simple pour display carton plastique



	25	mm	mm	mm			
8124390525	25		5,0	50	RAL9005	50	0,5
8124391025	25		5,0	100	RAL9005	50	0,7
8124391525	25		5,0	150	RAL9005	50	0,9
8124392025	25		5,0	200	RAL9005	50	1,1
8124390515	25		5,0	50	RAL9001	50	0,5
8124391015	25		5,0	100	RAL9001	50	0,7
8124391515	25		5,0	150	RAL9001	50	0,9
8124392015	25		5,0	200	RAL9001	50	1,1

Artikel nur auf Anfrage erhältlich / only on request / uniquement sur demande / solamente a pedido

## Einfachhaken mit Klemmvorrichtung Kunststoff

Universal single hook with clip device plastics

Gancho simple universal con dispositivo de clip plástico

Crochet simple avec dispositif de blocage plastique



		mm	mm	mm			
8123390525		20	5,0	50	RAL9005	50	0,4
8123391025		20	5,0	100	RAL9005	50	0,5
8123391525		20	5,0	150	RAL9005	50	0,6
8123390515		20	5,0	50	RAL9001	50	0,4
8123391015		20	5,0	100	RAL9001	50	0,5
8123391515		20	5,0	150	RAL9001	50	0,6

Artikel nur auf Anfrage erhältlich / only on request / uniquement sur demande / solamente a pedido

## Einfachhaken für Lamellenwand Kunststoff

Single hook for slatwall plastics

Gancho simple para lamas plástico

Crochet simple pour fond lame plastique









		mm	mm	mm			
8122390525		25	5,0	50	RAL9005	50	0,7
8122391025		25	5,0	100	RAL9005	50	0,8
8122391525		25	5,0	150	RAL9005	50	1,1
8122392025		25	5,0	200	RAL9005	50	1,2
8122392525		25	5,0	250	RAL9005	50	1,3
8122390515		25	5,0	50	RAL9001	50	0,7
8122391015		25	5,0	100	RAL9001	50	0,8
8122391515		25	5,0	150	RAL9001	50	1,1
8122392015		25	5,0	200	RAL9001	50	1,2
8122392515		25	5,0	250	RAL9001	50	1,3

Artikel nur auf Anfrage erhältlich / only on request / uniquement sur demande / solamente a pedido

## Wir biegen Lösungen

### Doppelhaken für Lochwand Kunststoff

Double hook for pegboard plastics  
Gancho doble para fondo perforado plástico  
Crochet double pour fond perforé plastique







 25	 mm	 mm	 mm			 kg
8125400525	25	5,0	50	RAL9005	50	0,7
8125401025	25	5,0	100	RAL9005	50	1,0
8125401525	25	5,0	150	RAL9005	50	1,3
8125402025	25	5,0	200	RAL9005	50	1,6
8125400515	25	5,0	50	RAL9001	50	0,7
8125401015	25	5,0	100	RAL9001	50	1,0
8125401515	25	5,0	150	RAL9001	50	1,3
8125402015	25	5,0	200	RAL9001	50	1,6

Artikel nur auf Anfrage erhältlich / only on request / uniquement sur demande / solamente a pedido

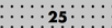

### Doppelhaken für Papprückwand Kunststoff







Double hook for cardboard displays plastics  
Gancho doble para expositor de carton plástico  
Crochet double pour display carton plastique

 25	 mm	 mm	 mm			 kg
8124400525	25	5,0	50	RAL9005	50	0,7
8124401025	25	5,0	100	RAL9005	50	1,0
8124401525	25	5,0	150	RAL9005	50	1,3
8124402025	25	5,0	200	RAL9005	50	1,6
8124400515	25	5,0	50	RAL9001	50	0,7
8124401015	25	5,0	100	RAL9001	50	1,0
8124401515	25	5,0	150	RAL9001	50	1,3
8124402015	25	5,0	200	RAL9001	50	1,6

Artikel nur auf Anfrage erhältlich / only on request / uniquement sur demande / solamente a pedido









### Blisterhaken mit Klemmvorrichtung Kunststoff

	 mm	 mm	 mm			 kg
8123410525	20	5,0	50	RAL9005	50	0,6
8123411025	20	5,0	100	RAL9005	50	0,7
8123411525	20	5,0	150	RAL9005	50	0,8
8123410515	20	5,0	50	RAL9001	50	0,6
8123411015	20	5,0	100	RAL9001	50	0,7
8123411515	20	5,0	150	RAL9001	50	0,8

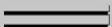
Artikel nur auf Anfrage erhältlich / only on request / uniquement sur demande / solamente a pedido



### Doppelhaken für Lamellenwand Kunststoff

	 mm	 mm	 mm			 kg
8122400525	30	5,0	50	RAL9005	50	0,8
8122401025	30	5,0	100	RAL9005	50	1,1
8122401525	30	5,0	150	RAL9005	50	1,4
8122402025	30	5,0	200	RAL9005	50	1,7
8122402525	30	5,0	250	RAL9005	50	2,0
8122400515	30	5,0	50	RAL9001	50	0,8
8122401015	30	5,0	100	RAL9001	50	1,1
8122401515	30	5,0	150	RAL9001	50	1,4
8122402015	30	5,0	200	RAL9001	50	1,7
8122402515	30	5,0	250	RAL9001	50	2,0

Artikel nur auf Anfrage erhältlich / only on request / uniquement sur demande / solamente a pedido



# HOHAGE

---

Wir biegen Lösungen

1

## **Einfach- und Doppelhaken**

Single and double hooks  
Ganchos simples y dobles  
Broches simples et doubles

## Lochwandhaken verzinkt

Single hook zinc

Gancho simple zincado

Crochet simple zingué

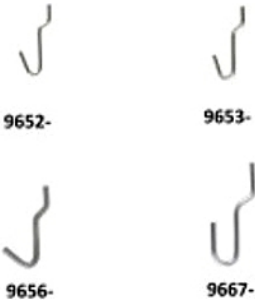

15 / 25			mm	mm		kg
9652-020035A			2,0	35	100	0,1
9653-025035A			2,5	35	100	0,3
9656-034040A			3,4	40	100	0,4
9667-034050A			3,4	50	100	0,6

## Lochhaken verzinkt

Ceiling anchor hook zinc

Gancho techo zincado

Crochet accrochage à plafond zingué

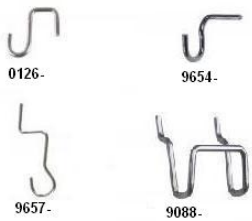

15 / 25			mm	mm		kg
9657-020045A			2,0	45	100	0,2
9654-025024A			2,5	24	100	0,3
0126-030025A			3,0	25	100	0,4
9088-025030A			2,5	30	100	0,6

## Schlaufenhaken ca. 10 Grad Vorsteigung, verzinkt

Double loop hook gradient approx. 10 degrees, zinc

Gancho doble para fondo perforado angulo aprox. 10 grados, zincado

Broche double en forme de boucle pente environ 10 degrés, zingué



15 / 25	mm		mm	mm		kg
9688-025040A	25/30		2,5	40	50	0,6
9688-025060A	25/30		2,5	60	25	0,4
9688-025080A	25/30		2,5	80	25	1,0
9688-025100A	25/30		2,5	100	25	1,2

## Schlaufenhaken ca. 10 Grad Vorsteigung, verzinkt

Double loop hook gradient approx. 10 degrees, zinc

Gancho doble para fondo perforado angulo aprox. 10 grados, zincado

Broche double en forme de boucle pente environ 10 degrés, zingué



15 / 25	mm		mm	mm		kg
9688-030100A	25/30		3,0	100	25	1,7
9688-030120A	25/30		3,0	120	25	1,9
9688-030140A	25/30		3,0	140	50	2,1
9688-030160A	25/30		3,0	160	50	2,3
9688-030180A	25/30		3,0	180	50	2,5
9688-030200A	25/30		3,0	200	50	2,7

## Schlaufenhaken ca. 10 Grad Vorsteigung, verzinkt

**Double loop hook** gradient approx. 10 degrees, zinc

**Gancho doble fondo perforado** angulo aprox. 10 grados, zincado

**Broche double en forme de boucle** pente environ 10 degrés, zinguée

15°/25°	mm	mm	mm	mm	mm	kg	
9688-034100A	25/30			3,4	100	25	2,5
9688-034120A	25/30			3,4	120	25	2,7
9688-034140A	25/30			3,4	140	50	2,5
9688-034160A	25/30			3,4	160	50	3,1
9688-034200A	25/30			3,4	200	50	3,5



## Schlaufenhaken ca. 10 Grad Vorsteigung, verzinkt

**Double loop hook** gradient approx. 10 degrees, zinc

**Gancho doble para fondo perforado** angulo aprox. 10 grados, zincado

**Broche double en forme de boucle** pente environ 10 degrés, zinguée

15°/25°	mm	mm	mm	mm	mm	kg	
9688-038200A	25/30			3,8	200	50	4,5
9688-038250A	25/30			3,8	250	50	5,4
9688-038275A	25/30			3,8	275	50	5,9
9688-038300A	25/30			3,8	300	50	6,3



## Schlaufenhaken ca. 15 Grad Vorsteigung, verzinkt

**Double loop hook** gradient approx. 15 degrees, zinc

**Gancho doble para fondo perforado** angulo aprox. 15 grados, zincado

**Broche double en forme de boucle** pente environ 15 degrés, zinguée

15°/25°	mm	mm	mm	mm	mm	kg	
9689-038200A	25/30			3,8	200	50	4,5
9689-038275A	25/30			3,8	275	50	5,8
9689-038340A	25/30			3,8	340	50	6,9
9689-038370A	25/30			3,8	370	50	7,3



## Schlaufenhaken ca. 15 Grad Vorsteigung, verzinkt

**Double loop hook** gradient approx. 15 degrees, zinc

**Gancho doble para fondo perforado** angulo aprox. 15 grados, zincado

**Broche double en forme de boucle** pente environ 15 degrés, zinguée

15°/25°	mm	mm	mm	mm	mm	kg	
9689-040300A	25/30			4,0	300	50	6,4
9689-040340A	25/30			4,0	340	50	7,3
9689-040370A	25/30			4,0	370	50	8,2
9689-040400A	25/30			4,0	400	50	9,1



## Einfachhaken verzinkt

Single hook zinc

Gancho simple zincado

Crochet simple zingué



15		mm (mm)	mm	mm		kg
9781-034060A		15(3,4)	3,4	60	50	1,2
9781-034080A		15(3,4)	3,4	80	50	1,3
9781-034100A		15(3,4)	3,4	100	50	1,4
9781-034120A		15(3,4)	3,4	120	50	1,6
9781-034160A		15(3,4)	3,4	160	50	1,8
9781-034200A		15(3,4)	3,4	200	50	2,1

## Einfachhaken verzinkt

Single hook zinc

Gancho simple zincado

Crochet simple zingué



15		mm (mm)	mm	mm		kg
9781-048120A		15(3,4)	4,8	120	50	2,7
9781-048160A		15(3,4)	4,8	160	50	3,7
9781-048200A		15(3,4)	4,8	200	50	4,7

## Einfachhaken mit Kugel verzinkt

Single hook with ball tip end zinc

Gancho simple con terminal bola zincado

Crochet simple à bille zingué



15	25	mm (mm)	mm	mm		kg
9773-034045A	9673-034045A	30/25(2,5)	3,4	45	50	0,9
9773-034060A	9673-034060A	30/25(2,5)	3,4	60	50	1,1
9773-034080A	9673-034080A	30/25(2,5)	3,4	80	50	1,3
9773-034100A	9673-034100A	30/25(2,5)	3,4	100	50	1,5
9773-034120A	9673-034120A	30/25(2,5)	3,4	120	50	1,7
9773-034140A	9673-034140A	30/25(2,5)	3,4	140	50	1,9
9773-034160A	9673-034160A	30/25(2,5)	3,4	160	50	2,1
9773-034180A	9673-034180A	30/25(2,5)	3,4	180	50	2,3
9773-034200A	9673-034200A	30/25(2,5)	3,4	200	50	2,5
9773-034220A	9673-034220A	30/25(2,5)	3,4	220	50	2,7

## Einfachhaken mit Kugel verzinkt

Single hook with ball tip end zinc

Gancho simple con terminal bola zincado





Crochet simple à bille zingué



15	25	mm (mm)	mm	mm		kg
9778-034060A	9678-034060A	30/25(3,4)	3,4	60	50	1,2
9778-034080A	9678-034080A	30/25(3,4)	3,4	80	50	1,4
9778-034100A	9678-034100A	30/25(3,4)	3,4	100	50	1,6
9778-034120A	9678-034120A	30/25(3,4)	3,4	120	50	1,8
9778-034140A	9678-034140A	30/25(3,4)	3,4	140	50	2,0
9778-034160A	9678-034160A	30/25(3,4)	3,4	160	50	2,2
9778-034180A	9678-034180A	30/25(3,4)	3,4	180	50	2,4
9778-034200A	9678-034200A	30/25(3,4)	3,4	200	50	2,6
9778-034220A	9678-034220A	30/25(3,4)	3,4	220	50	2,8

## Einfachhaken mit Kugel verzinkt





Single hook with ball tip end zinc  
Gancho simple con terminal bola zincado  
Crochet simple à bille zingué

15	25					
9786-040060A	9686-040060A	30/25(3,4)	4,0	60	50	1,5
9786-040080A	9686-040080A	30/25(3,4)	4,0	80	50	1,7
9786-040100A	9686-040100A	30/25(3,4)	4,0	100	50	1,9
9786-040120A	9686-040120A	30/25(3,4)	4,0	120	50	2,1
9786-040140A	9686-040140A	30/25(3,4)	4,0	140	50	2,3
9786-040160A	9686-040160A	30/25(3,4)	4,0	160	50	2,5
9786-040180A	9686-040180A	30/25(3,4)	4,0	180	50	2,7
9786-040200A	9686-040200A	30/25(3,4)	4,0	200	50	2,9
9786-040220A	9686-040220A	30/25(3,4)	4,0	220	50	3,1



## Einfachhaken verzinkt





Single hook zinc  
Gancho simple zincado  
Crochet simple zingué

15	25					
9340-048150A	9240-048150A	30/25(3,4)	4,8	150	50	3,2
9340-048200A	9240-048200A	30/25(3,4)	4,8	200	50	4,0
9340-048250A	9240-048250A	30/25(3,4)	4,8	250	50	4,7
9340-048300A	9240-048300A	30/25(3,4)	4,8	300	50	5,4
9340-048400A	9240-048400A	30/25(3,4)	4,8	400	50	6,8



## Einfachhaken verzinkt





Single hook zinc  
Gancho simple zincado  
Crochet simple zingué

15	25					
9787-060100A	9687-060100A	45/50(3,8)	6,0	100	50	4,4
9787-060150A	9687-060150A	45/50(3,8)	6,0	150	50	5,5
9787-060200A	9687-060200A	45/50(3,8)	6,0	200	50	6,5
9787-060250A	9687-060250A	45/50(3,8)	6,0	250	50	7,5
9787-060300A	9687-060300A	45/50(3,8)	6,0	300	50	8,5
9787-060350A	9687-060350A	45/50(3,8)	6,0	350	50	9,5
9787-060400A	9687-060400A	45/50(3,8)	6,0	400	50	10,5
9787-060450A	9687-060450A	45/50(3,8)	6,0	450	50	11,5



## Einfachhaken verzinkt

Single hook zinc  
Gancho simple zincado  
Crochet simple zingué

15	25					
9790-080200A	9690-080200A	45/50(3,8)	8,0	200	50	11,8
9790-080300A	9690-080300A	45/50(3,8)	8,0	300	50	14,6
9790-080400A	9690-080400A	45/50(3,8)	8,0	400	50	18,7
9790-080500A	9690-080500A	45/50(3,8)	8,0	500	50	24,8
9791-100300A	9691-100300A	45/50(3,8)	10,0	300	50	22,5
9791-100400A	9691-100400A	45/50(3,8)	10,0	400	50	30,7
9791-100500A	9691-100500A	45/50(3,8)	10,0	500	50	36,2









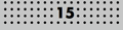
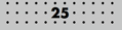

## Doppelhaken verzinkt

**Double hook** zinc  
**Gancho doble** zincado  
**Crochet double** zingué







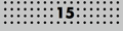
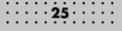

						
9794-034100A	9694-034100A	45/50(2,5)	3,4	100	50	2,5
9794-034150A	9694-034150A	45/50(2,5)	3,4	150	50	3,2
9794-034200A	9694-034200A	45/50(2,5)	3,4	200	50	3,9

## Doppelhaken verzinkt

**Double hook** zinc  
**Gancho doble** zincado  
**Crochet double** zingué







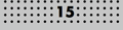
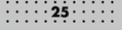

						
9122-034100A	9022-034100A	45/50(3,8)	3,4	100	50	3,0
9122-034150A	9022-034150A	45/50(3,8)	3,4	150	50	3,7
9122-034200A	9022-034200A	45/50(3,8)	3,4	200	50	4,4

## Doppelhaken verzinkt

**Double hook** zinc  
**Gancho doble** zincado  
**Crochet double** zingué







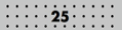

						
9307-040150A	9207-040150A	45/50(3,8)	4,0	150	50	4,8
9307-040200A	9207-040200A	45/50(3,8)	4,0	200	50	5,7
9307-040250A	9207-040250A	45/50(3,8)	4,0	250	50	6,6
9307-040300A	9207-040300A	45/50(3,8)	4,0	300	50	7,5

## Doppelhaken verzinkt





**Double hook** zinc  
**Gancho doble** zincado  
**Crochet double** zingué



						
9304-048200A	9204-048200A	45/50(3,8)	4,8	200	50	7,8
9304-048250A	9204-048250A	45/50(3,8)	4,8	250	50	9,4
9304-048300A	9204-048300A	45/50(3,8)	4,8	300	50	10,0
9304-048400A	9204-048400A	45/50(3,8)	4,8	400	50	12,2

## Doppelhaken verzinkt

**Double hook** zinc  
**Gancho doble** zincado  
**Crochet double** zingué





15	25					
9306-060200A	9206-060200A	45/50(3,8)	6,0	200	50	11,8
9306-060300A	9206-060300A	45/50(3,8)	6,0	300	50	16,3
9306-060400A	9206-060400A	45/50(3,8)	6,0	400	50	20,8

Mindestbestellmenge 1000 Stück je Sorte / minimum order quantity 1000 pieces  
Quantité minimale de commande: 1000 pièces / cantidad mínima por pedido: 1000 unidades



## Schwerlasthaken verzinkt

**Triple hook heavy type** zinc  
**Gancho triple cargas pesadas** zincado  
**Crochet triple** zingué





15	25					
2491582010	2490582010	45/50(3,8)	3,8/6,0	200	50	16,2
2491583010	2490583010	45/50(3,8)	3,8/6,0	300	50	17,3
2491584010	2490584010	45/50(3,8)	3,8/6,0	400	50	23,1
2491585010	2490585010	45/50(3,8)	3,8/6,0	500	50	29,0

Artikel nur auf Anfrage erhältlich / only on request / uniquement sur demande / solamente a pedido



## Schwerlasthaken verzinkt

**Triple hook heavy type** zinc  
**Gancho triple cargas pesadas** zincado  
**Crochet triple** zingué

15	25					
2491593010	2490593010	45/50(3,8)	3,8/8,0	300	50	18,3
2491594010	2490594010	45/50(3,8)	3,8/8,0	400	50	24,1
2491595010	2490595010	45/50(3,8)	3,8/8,0	500	50	30,0

Artikel nur auf Anfrage erhältlich / only on request / uniquement sur demande / solamente a pedido









## Einfachhaken für Lochwand Kunststoff

Single hook for pegboard plastics

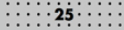
Gancho simple para fondo perforado plástico

Crochet simple pour fond perforé plastique



						
8125390525	25	5,0	50	RAL9005	50	0,5
8125391025	25	5,0	100	RAL9005	50	0,7
8125391525	25	5,0	150	RAL9005	50	0,9
8125392025	25	5,0	200	RAL9005	50	1,1
8125390515	25	5,0	50	RAL9001	50	0,5
8125391015	25	5,0	100	RAL9001	50	0,7
8125391515	25	5,0	150	RAL9001	50	0,9
8125392015	25	5,0	200	RAL9001	50	1,1

Artikel nur auf Anfrage erhältlich / only on request / uniquement sur demande / solamente a pedido







## Einfachhaken für Papprückwand Kunststoff

Single hook for cardboard displays plastics

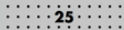
Gancho simple para expositor de carton plástico

Crochet simple pour display carton plastique



						
8124390525	25	5,0	50	RAL9005	50	0,5
8124391025	25	5,0	100	RAL9005	50	0,7
8124391525	25	5,0	150	RAL9005	50	0,9
8124392025	25	5,0	200	RAL9005	50	1,1
8124390515	25	5,0	50	RAL9001	50	0,5
8124391015	25	5,0	100	RAL9001	50	0,7
8124391515	25	5,0	150	RAL9001	50	0,9
8124392015	25	5,0	200	RAL9001	50	1,1

Artikel nur auf Anfrage erhältlich / only on request / uniquement sur demande / solamente a pedido







## Einfachhaken mit Klemmvorrichtung Kunststoff

Universal single hook with clip device plastics

Gancho simple universal con dispositivo de clip plástico

Crochet simple avec dispositif de blocage plastique



						
8123390525	20	5,0	50	RAL9005	50	0,4
8123391025	20	5,0	100	RAL9005	50	0,5
8123391525	20	5,0	150	RAL9005	50	0,6
8123390515	20	5,0	50	RAL9001	50	0,4
8123391015	20	5,0	100	RAL9001	50	0,5
8123391515	20	5,0	150	RAL9001	50	0,6

Artikel nur auf Anfrage erhältlich / only on request / uniquement sur demande / solamente a pedido







## Einfachhaken für Lamellenwand Kunststoff

Single hook for slatwall plastics

Gancho simple para lamas plástico

Crochet simple pour fond lame plastique









						
8122390525	25	5,0	50	RAL9005	50	0,7
8122391025	25	5,0	100	RAL9005	50	0,8
8122391525	25	5,0	150	RAL9005	50	1,1
8122392025	25	5,0	200	RAL9005	50	1,2
8122392525	25	5,0	250	RAL9005	50	1,3
8122390515	25	5,0	50	RAL9001	50	0,7
8122391015	25	5,0	100	RAL9001	50	0,8
8122391515	25	5,0	150	RAL9001	50	1,1
8122392015	25	5,0	200	RAL9001	50	1,2
8122392515	25	5,0	250	RAL9001	50	1,3

Artikel nur auf Anfrage erhältlich / only on request / uniquement sur demande / solamente a pedido

## Doppelhaken für Lochwand Kunststoff

Double hook for pegboard plastics  
Gancho doble para fondo perforado plastico  
Crochet double pour fond perforé plastique







 25						
	mm	mm	mm			kg
8125400525	25	5,0	50	RAL9005	50	0,7
8125401025	25	5,0	100	RAL9005	50	1,0
8125401525	25	5,0	150	RAL9005	50	1,3
8125402025	25	5,0	200	RAL9005	50	1,6
8125400515	25	5,0	50	RAL9001	50	0,7
8125401015	25	5,0	100	RAL9001	50	1,0
8125401515	25	5,0	150	RAL9001	50	1,3
8125402015	25	5,0	200	RAL9001	50	1,6

Artikel nur auf Anfrage erhältlich / only on request / uniquement sur demande / solamente a pedido



## Doppelhaken für Papprückwand Kunststoff

Double hook for cardboard displays plastics  
Gancho doble para expositor de carton plastico  
Crochet double pour display carton plastique







 25						
	mm	mm	mm			kg
8124400525	25	5,0	50	RAL9005	50	0,7
8124401025	25	5,0	100	RAL9005	50	1,0
8124401525	25	5,0	150	RAL9005	50	1,3
8124402025	25	5,0	200	RAL9005	50	1,6
8124400515	25	5,0	50	RAL9001	50	0,7
8124401015	25	5,0	100	RAL9001	50	1,0
8124401515	25	5,0	150	RAL9001	50	1,3
8124402015	25	5,0	200	RAL9001	50	1,6

Artikel nur auf Anfrage erhältlich / only on request / uniquement sur demande / solamente a pedido



## Blisterhaken mit Klemmvorrichtung Kunststoff

Universal double hook with clip device plastics  
Gancho doble universal con dispositivo de clip plastico  
Crochet double avec dispositif de blocage plastique







						
	mm	mm	mm			kg
8123410525	20	5,0	50	RAL9005	50	0,6
8123411025	20	5,0	100	RAL9005	50	0,7
8123411525	20	5,0	150	RAL9005	50	0,8
8123410515	20	5,0	50	RAL9001	50	0,6
8123411015	20	5,0	100	RAL9001	50	0,7
8123411515	20	5,0	150	RAL9001	50	0,8

Artikel nur auf Anfrage erhältlich / only on request / uniquement sur demande / solamente a pedido



## Doppelhaken für Lamellenwand Kunststoff

Double hook for slatwall plastics  
Gancho doble para lamas plastico  
Crochet double pour fond lame plastique

						
	mm	mm	mm			kg
8122400525	30	5,0	50	RAL9005	50	0,8
8122401025	30	5,0	100	RAL9005	50	1,1
8122401525	30	5,0	150	RAL9005	50	1,4
8122402025	30	5,0	200	RAL9005	50	1,7
8122402525	30	5,0	250	RAL9005	50	2,0
8122400515	30	5,0	50	RAL9001	50	0,8
8122401015	30	5,0	100	RAL9001	50	1,1
8122401515	30	5,0	150	RAL9001	50	1,4
8122402015	30	5,0	200	RAL9001	50	1,7
8122402515	30	5,0	250	RAL9001	50	2,0

Artikel nur auf Anfrage erhältlich / only on request / uniquement sur demande / solamente a pedido



# HOHAGE

Wir biegen Lösungen



## **Systemhaken mit Schnellbefestigung**

Fast entry hooks  
Ganchos con cierre giratorio  
Crochets à système

## Einfachhaken mit Klappverschluss verzinkt

Single hook with locking device zinc

Gancho simple con cierre basculante zincado

Crochet simple avec arrêt de sécurité zingué



15	25	mm	mm	mm	kg	
3140651042	3040661042	30/25	4,8	100	50	7,7
3140651542	3040661542	30/25	4,8	150	50	8,4
3140652042	3040662042	30/25	4,8	200	50	9,1
3140652542	3040662542	30/25	4,8	250	50	9,8
3140653042	3040663042	30/25	4,8	300	50	10,5
3140654042	3040664042	30/25	4,8	400	50	12,0

## Einfachhaken mit Klappverschluss verzinkt

Single hook with locking device zinc

Gancho simple con cierre basculante zincado

Crochet simple avec arrêt de sécurité zingué



15	25	mm	mm	mm	kg	
3030062042	-	30	6,0	200	50	11,0
3030063042	-	30	6,0	300	50	13,4
3030064042	-	30	6,0	400	50	15,7

## Einfachhaken mit Klappverschluss verzinkt

Single hook with locking device zinc

Gancho simple con cierre basculante zincado

Crochet simple avec arrêt de sécurité zingué



15	25	mm	mm	mm	kg	
3030082042	-	30	8,0	200	50	12,1
3030083042	-	30	8,0	300	50	14,5
3030084042	-	30	8,0	400	50	16,8

## Einfachhaken mit Klappverschluss verzinkt

Single hook with locking device zinc

Gancho simple con cierre basculante zincado

Crochet simple avec arrêt de sécurité zingué







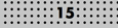
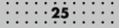

15	25	mm	mm	mm	kg	
4501062010	5001062010*	45/50	6,0	200	50	12,0
4501063010	5001063010*	45/50	6,0	300	50	14,4
4501064010	5001064010*	45/50	6,0	400	50	16,7

\* Artikel nur auf Anfrage erhältlich / only on request / uniquement sur demande / solamente a pedido

## Einfachhaken mit Klappverschluss verzinkt

Single hook with locking device zinc  
 Gancho simple con cierre basculante zincado  
 Crochet simple avec arrêt de sécurité zingué







 15	 25					
4501082010	5001082010*	45/50	8,0	200	50	13,1
4501083010	5001083010*	45/50	8,0	300	50	15,5
4501084010	5001084010*	45/50	8,0	400	50	17,8
4501085010	5001085010*	45/50	8,0	500	25	20,1

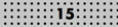
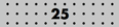

\* Artikel nur auf Anfrage erhältlich / only on request / uniquement sur demande / solamente a pedido

## Einfachhaken mit Klappverschluss verzinkt

Single hook with locking device zinc  
 Gancho simple con cierre basculante zincado  
 Crochet simple avec arrêt de sécurité zingué

 15	 25					
4501103010	5001103010*	45/50	10,0	300	25	29,0
4501104010	5001104010*	45/50	10,0	400	25	35,3
4501105010	5001105010*	45/50	10,0	500	25	41,5



\* Artikel nur auf Anfrage erhältlich / only on request / uniquement sur demande / solamente a pedido



## Rutschhaken mit Klappverschluss verzinkt

Slide hook with locking device zinc

Gancho doble inclinado con cierre basculante zincado

Crochet de glissement avec arrêt de sécurité zingué



15	25	mm	mm	mm	kg	
3097703542	-	30	4,8	350	50	15,5

## Doppelhaken mit Klappverschluss verzinkt

Double hook with locking device zinc

Gancho doble con cierre basculante zincado

Crochet double avec arrêt de sécurité zingué



15	25	mm	mm	mm	kg	
3040538042	-	30	4,0	80	50	5,9
3009341042	-	30	4,0	100	50	6,1
3009340242	-	30	4,0	120	50	6,5
3009340342	-	30	4,0	150	50	7,0
3109792042	3009762042*	30/25	4,8	200	50	9,4
3109792542	3009762542*	30/25	4,8	250	50	10,1
3109793042	3009763042*	30/25	4,8	300	50	10,8
3109794042	3009764042*	30/25	4,8	400	50	12,3

\* Artikel nur auf Anfrage erhältlich / only on request / uniquement sur demande / solamente a pedido

## Doppelhaken mit Klappverschluss verzinkt

Double hook with locking device zinc

Gancho doble con cierre basculante zincado

Crochet double avec arrêt de sécurité zingué



15	25	mm	mm	mm	kg	
4502052010	5002052010*	45/50	4,8	200	50	14,0
4502053010	5002053010*	45/50	4,8	300	50	16,9
4502054010	5002054010*	45/50	4,8	400	50	19,8

\* Artikel nur auf Anfrage erhältlich / only on request / uniquement sur demande / solamente a pedido

## Doppelhaken mit Klappverschluss verzinkt

Double hook with locking device zinc

Gancho doble con cierre basculante zincado

Crochet double avec arrêt de sécurité zingué



15	25	mm	mm	mm	kg	
4502062010	5002062010*	45/50	6,0	200	50	18,5
4502063010	5002063010*	45/50	6,0	300	50	21,4
4502064010	5002064010*	45/50	6,0	400	50	24,3

\* Artikel nur auf Anfrage erhältlich / only on request / uniquement sur demande / solamente a pedido

## Schwerlasthaken mit Klappverschluss verzinkt

Triple hook heavy type with locking device zinc

Gancho triple con cierre basculante zincado

Crochet lourd triple avec arrêt de sécurité zingué

15	25	mm	mm	mm	mm	kg
4563042510*	5063042510*	45/50	3,8/6,0	250	50	20,5
4563043010	5063043010*	45/50	3,8/6,0	300	50	23,4
4563044010*	5063044010*	45/50	3,8/6,0	400	50	26,3



\* Mindestbestellmenge 500 Stück / minimum order quantity 500 pieces

\* Quantité minimale de commande: 500 pièces / cantidad mínima por pedido: 500 unidades

## Schwerlasthaken mit Klappverschluss verzinkt

Triple hook heavy type with locking device zinc

Gancho triple con cierre basculante zincado

Crochet lourd triple avec arrêt de sécurité zingué

15	25	mm	mm	mm	mm	kg
4583042510*	5083042510*	45/50	3,8/8,0	250	50	22,5
4583043010*	5083043010*	45/50	3,8/8,0	300	50	25,4
4583044010	5083044010*	45/50	3,8/8,0	400	50	28,3
4583045010**	5083045010**	45/50	3,8/8,0	500	50	31,2



\* Mindestbestellmenge 500 Stück / minimum order quantity 500 pieces

\* Quantité minimale de commande: 500 pièces / cantidad mínima por pedido: 500 unidades

\*\* Artikel nur auf Anfrage erhältlich / only on request / uniquement sur demande / solamente a pedido

## Doppelhaken offen mit Klappverschluss innere Weite ca. 40 mm, verzinkt

Double hook open with locking device inner width approx. 40 mm, zinc

Gancho doble abierto con cierre basculante aprox. 40 mm, zincado

Crochet double ouvert avec arrêt de sécurité largeur intérieure env. 40 mm, zingué

15	25	mm	mm	mm	mm	kg
7505082010		75	8,0	200	25	29,0
7505083010		75	8,0	300	25	37,1
7505084010		75	8,0	400	25	45,1
7505085010		75	8,0	500	25	53,2



Mindestbestellmenge 500 Stück je Sorte / minimum order quantity 500 pieces

Quantité minimale de commande: 500 pièces / cantidad mínima por pedido: 500 unidades

## Doppelhaken offen mit Klappverschluss innere Weite ca. 40 mm, verzinkt

Double hook open with locking device inner width approx. 40mm, zinc

Gancho doble abierto con cierre basculante aprox. 40mm, zincado

Crochet double ouvert avec arrêt de sécurité largeur intérieure env. 40 mm, zingué

15	25	mm	mm	mm	mm	kg
7505103010		75	10,0	300	25	54,6
7505104010		75	10,0	400	25	67,2
7505105010		75	10,0	500	25	79,8



Artikel nur auf Anfrage erhältlich / only on request / uniquement sur demande / solamente a pedido

## System-Steckplatte verzinkt

System plate zinc  
Placa sistema zincado  
Platine renforcée zinguée



15	25	mm	mm				kg
2415490302	-	30	85			50	3,6

## Einfachhaken für System-Steckplatte verzinkt

Single hook for special system plate zinc  
Gancho simple para placa sistema zincado  
Crochet simple pour platine renforcée zingué



15		mm	mm	mm	mm		kg
2415632902		30		4,8	200	50	5,0
2415633902		30		4,8	300	50	6,7
2415634902		30		4,8	400	50	8,5

Mindestbestellmenge 500 Stück je Sorte / minimum order quantity 500 pieces  
Quantité minimale de commande: 500 pièces / cantidad mínima por pedido: 500 unidades

## Einfachhaken für System-Steckplatte verzinkt

Single hook for special system plate zinc  
Gancho simple para placa sistema zincado  
Crochet simple pour platine renforcée zingué



15		mm		mm	mm		kg
2415652902		30		6,0	200	50	7,6
2415653902		30		6,0	300	50	9,9
2415654902		30		6,0	400	50	12,1

Mindestbestellmenge 500 Stück / minimum order quantity 500 pieces  
Quantité minimale de commande: 500 pièces / cantidad mínima por pedido: 500 unidades

## Einfachhaken für System-Steckplatte verzinkt

Single hook for special system plate zinc  
Gancho simple para placa sistema zincado  
Crochet simple pour platine renforcée zingué



15		mm		mm	mm		kg
2415672902*		30		8,0	200	25	12,2
2415673902*		30		8,0	300	25	16,4
2415674902*		30		8,0	400	25	20,2
2415675902**		30		8,0	500	25	24,8

\* Mindestbestellmenge 500 Stück / minimum order quantity 500 pieces  
\* Quantité minimale de commande: 500 pièces / cantidad mínima por pedido: 500 unidades  
\*\* Artikel nur auf Anfrage erhältlich / only on request / uniquement sur demande / solamente a pedido

## Doppelhaken für System-Steckplatte verzinkt

Double hook for special system plate zinc  
 Gancho doble para placa sistema zincado  
 Crochet double pour platine renforcée zingué

15:		mm	mm	mm		kg
2415762042		30	4,8	200	50	9,2
2415763042		30	4,8	300	50	11,8
2415764042		30	4,8	400	50	14,8



## Schwerlasthaken für System-Steckplatte verzinkt

Triple hook heavy type for special system plate zinc  
 Gancho triple reforzado para placa sistema zincado  
 Crochet lourd triple pour platine renforcée zingué

15:		mm	mm	mm		kg
2415583010**		30	3,8/6,0	300	25	17,6
2415584010**		30	3,8/6,0	400	25	21,7
2415585010**		30	3,8/6,0	500	25	25,8
2415603010*		30	3,8/8,0	300	25	23,3
2415604010*		30	3,8/8,0	400	25	29,1
2415605010**		30	3,8/8,0	500	25	35,0



\* Mindestbestellmenge 500 Stück / minimum order quantity 500 pieces

\* Quantité minimale de commande: 500 pièces / cantidad mínima por pedido: 500 unidades

\*\* Artikel nur auf Anfrage erhältlich / only on request / uniquement sur demande / solamente a pedido

# HOHAGE

Wir biegen Lösungen



## **Systemhaken mit Preisauszeichnung / Zubehör**

**System hooks with price labelling / Accessories**

**Ganchos con portaprecios / Accesorios**

**Crochets à système avec affichage du prix / Accessoires**

## Einfachhaken mit Etikettenträger verzinkt

Single hook with top label holder zinc

Gancho simple con tope etiqueta zincado

Crochet simple équipé d'un bras porte-prix zingué



15	25	mm	mm	mm	kg	
6093401542	6092401510	30/25(3,4)	4,8	150	50	5,7
6093402042	6092402010	30/25(3,4)	4,8	200	50	7,0
6093402542	6092402510	30/25(3,4)	4,8	250	50	8,2
6093403042	6092403010	30/25(3,4)	4,8	300	50	9,6
6093404042	6092404010	30/25(3,4)	4,8	400	50	12,2

Die passenden Pendeltaschen finden Sie auf der Seite 35.

## Einfachhaken mit Etikettenträger verzinkt

Single hook with top label holder zinc

Gancho simple con tope etiqueta zincado

Crochet simple équipé d'un bras porte-prix zingué



15	25	mm	mm	mm	kg	
6097872010	6096872010	45/50(3,8)	6,0	200	50	11,5
6097873010	6096873010	45/50(3,8)	6,0	300	50	16,5
6097874010	6096874010	45/50(3,8)	6,0	400	50	21,5
6097903010	6096903010	45/50(3,8)	8,0	300	25	18,6
6097904010	6096904010	45/50(3,8)	8,0	400	25	23,6

Die passenden Pendeltaschen finden Sie auf der Seite 35.

## Einfachhaken mit Klappverschluss und Etikettenträger verzinkt

Single hook with locking device and top label holder zinc

Gancho simple con cierre basculante y tope etiqueta zincado

Crochet simple avec arrêt de sécurité et bras porte-prix zingué



15	25	mm	mm	mm	kg	
6030062042	-	30	6,0	200	25	11,7
6030063042	-	30	6,0	300	25	17,6
6030064042	-	30	6,0	400	25	23,4

Die passenden Pendeltaschen finden Sie auf der Seite 35.

## Einfachhaken mit Klappverschluss und Etikettenträger verzinkt

Single hook with locking device and top label holder zinc

Gancho simple con cierre basculante y tope etiqueta zincado

Crochet simple avec arrêt de sécurité et bras porte-prix zingué



15	25	mm	mm	mm	kg	
6030082042	-	30	8,0	200	25	15,6
6030083042	-	30	8,0	300	25	23,4
6030084042	-	30	8,0	400	25	31,2

Die passenden Pendeltaschen finden Sie auf der Seite 35.

## Einfachhaken mit Klappverschluss und Etikettenträger verzinkt

Single hook with locking device and top label holder zinc  
 Gancho simple con cierre basculante y tope etiqueta zincado  
 Crochet simple avec arrêt de sécurité et bras porte-prix zingué

15	25	mm	mm	mm	mm	kg
6140651542	-	30	4,8	150	50	7,3
6140652042	-	30	4,8	200	50	9,2
6140652542	-	30	4,8	250	50	11,1
6140653042	-	30	4,8	300	50	13,0
6140654042	-	30	4,8	400	50	16,8

Die passenden Pendeltaschen finden Sie auf der Seite 35.



## Einfachhaken mit Klappverschluss und Etikettenträger verzinkt

Single hook with locking device and top label holder zinc  
 Gancho simple con cierre basculante y tope etiqueta zincado  
 Crochet simple avec arrêt de sécurité et bras porte-prix zingué

15	25	mm	mm	mm	mm	kg
6045062010	6050062010*	45/50	6,0	200	50	15,2
6045063010	6050063010*	45/50	6,0	300	50	18,5
6045064010	6050064010*	45/50	6,0	400	50	21,7

\* Artikel nur auf Anfrage erhältlich / only on request / uniquement sur demande / solamente a pedido  
 Die passenden Pendeltaschen finden Sie auf der Seite 35.



## Einfachhaken mit Klappverschluss und Etikettenträger verzinkt

Single hook with locking device and top label holder zinc  
 Gancho simple con cierre basculante y tope etiqueta zincado  
 Crochet simple avec arrêt de sécurité et bras porte-prix zingué

15	25	mm	mm	mm	mm	kg
6045082010	6050082010*	45/50	8,0	200	50	19,3
6045083010	6050083010*	45/50	8,0	300	50	24,6
6045084010	6050084010*	45/50	8,0	400	50	29,5

\* Artikel nur auf Anfrage erhältlich / only on request / uniquement sur demande / solamente a pedido  
 Die passenden Pendeltaschen finden Sie auf der Seite 35.



## Etikettenträger mit Klappverschluss verzinkt

Label holder with locking device zinc  
 Portaetiqueta con cierre basculante zincado  
 Bras porte-prix avec arrêt de sécurité zingué

15	25	mm	mm	mm	mm	kg
6040622010	6039622010	30/25	4,8	200	50	5,8
6040622510	6039622510	30/25	4,8	250	50	7,6
6040623510	6039623510	30/25	4,8	350	50	8,9
6040624510	6039624510	30/25	4,8	450	50	10,2
6040625510	6039625510	30/25	4,8	550	50	13,9

Mindestbestellmenge 500 Stück je Sorte / minimum order quantity 500 pieces  
 Quantité minimale de commande: 500 pièces / cantidad mínima por pedido: 500 unidades  
 Die passenden Pendeltaschen finden Sie auf der Seite 35.





## Doppelhaken mit Etikettenträger verzinkt

Double hook with top label holder zinc

Gancho doble con tope etiqueta zincado

Crochet double équipé d'un bras porte-prix zingué



15	25	mm (mm)	mm	mm	kg	
6091221542	6090221542	45/50(3,8)	3,4	150	50	6,2
6091222042	6090222042	45/50(3,8)	3,4	200	50	7,4

Die passenden Pendeltaschen finden Sie auf der Seite 35.

## Doppelhaken mit Etikettenträger verzinkt

Double hook with top label holder zinc

Gancho doble con tope etiqueta zincado

Crochet double équipé d'un bras porte-prix zingué



15	25	mm (mm)	mm	mm	kg	
6093072042	6092072042	45/50(3,8)	4,0	200	50	8,7
6093073042	6092073042	45/50(3,8)	4,0	300	50	9,9

Die passenden Pendeltaschen finden Sie auf der Seite 35.

## Doppelhaken mit Etikettenträger verzinkt

Double hook with top label holder zinc

Gancho doble con tope etiqueta zincado

Crochet double équipé d'un bras porte-prix zingué



15	25	mm (mm)	mm	mm	kg	
6093042042	6092042042	45/50(3,8)	4,8	200	50	10,6
6093042542	6092042542	45/50(3,8)	4,8	250	50	12,8
6093043042	6092043042	45/50(3,8)	4,8	300	50	14,4

Die passenden Pendeltaschen finden Sie auf der Seite 35.

## Doppelhaken mit Klappverschluss und Etikettenträger verzinkt

Double hook with locking device and top label holder zinc

Gancho doble con cierre basculante y tope etiqueta zincado

Crochet double avec arrêt de sécurité et bras porte-prix zingué



15	25	mm (mm)	mm	mm	kg	
6009341042	-	30	4,0	100	50	7,1
6009340242	-	30	4,0	120	50	7,5
6009340342	-	30	4,0	150	50	9,0
6109791542	6009761542*	30/25	4,8	150	50	10,5
6109792042	6009762042*	30/25	4,8	200	50	12,8
6109792542	6009762542*	30/25	4,8	250	50	15,1
6109793042	6009763042*	30/25	4,8	300	50	17,4
6109794042	6009764042*	30/25	4,8	400	50	22,0

\* Artikel nur auf Anfrage erhältlich / only on request / uniquement sur demande / solamente a pedido  
Die passenden Pendeltaschen finden Sie auf der Seite 35.

## Schwerlasthaken mit Klappverschluss und Etikettenträger verzinkt

Triple hook heavy type with locking device and top label holder zinc  
 Gancho triple cargas pesadas con cierre basculante y tope etiqueta zincado  
 Crochet lourd triple avec arrêt de sécurité et bras porte-prix zingué

15	25	mm	mm	mm			kg
6063043010**	6062043010**	45/50	3,8/6,0	300		50	24,0
6083043010*	6082043010*	45/50	3,8/8,0	300		50	29,4
6083044010*	6082044010*	45/50	3,8/8,0	400		50	35,3



\* Mindestbestellmenge 1000 Stück / minimum order quantity 1000 pieces  
 \* Quantité minimale de commande: 1000 pièces / cantidad mínima por pedido: 1000 unidades  
 \*\* Artikel nur auf Anfrage erhältlich / only on request / uniquement sur demande / solamente a pedido  
 Die passenden Pendeltaschen finden Sie auf der Seite 35.

## Einfachhaken mit seitlichem Etikettenträger verzinkt

Single hook with locking device and lateral label holder zinc  
 Gancho simple con porta-etiquetas lateral zincado  
 Crochet simple avec arrêt de sécurité et bras porte-prix latéral zingué

15	25	mm	mm	mm			kg
3040652010K**	-	30	4,8	200		50	10,1
3040653010K*	-	30	4,8	300		50	11,8



\* Mindestbestellmenge 500 Stück / minimum order quantity 500 pieces  
 \* Quantité minimale de commande: 500 pièces / cantidad mínima por pedido: 500 unidades  
 \*\* Artikel nur auf Anfrage erhältlich / only on request / uniquement sur demande / solamente a pedido

## Einfachhaken mit Klappverschluss und Etikettenträger mit Metallfahne verzinkt

Single hook with locking device and label holder with metal price flag zinc  
 Gancho simple con cierre basculante, porta-etiquetas con portaprecio metálico zincado  
 Crochet simple avec arrêt de sécurité et bras porte-prix et étiquette métallique zingué

15	25	mm	mm	mm	mm		kg
304065201028*	-	30	4,8	200	28x28(35)	50	11,2
304065011028*	-	30	4,8	300	28x28(35)	50	14,0
304065031028*	-	30	4,8	400	28x28(35)	50	16,8
304065151052*	-	30	4,8	150	28x30(52)	50	8,4
304065201052*	-	30	4,8	200	28x30(52)	50	11,2
304065301052*	-	30	4,8	300	28x30(52)	50	14,0
304065031052*	-	30	4,8	400	28x30(52)	50	16,8



\* Artikel nur auf Anfrage erhältlich / only on request / uniquement sur demande / solamente a pedido

## Einfachhaken mit Etikettenträger und Metallfahne 40 x 30 mm verzinkt

Single hook with label holder and metal price flag 40 x 30 mm zinc  
 Gancho simple con porta-etiquetas y portaprecio metálico 40 x 30 mm zincado  
 Crochet simple avec bras porte-prix et étiquette métallique 40 x 30 mm zingué

15	25	mm (mm)	mm	mm			kg
2491612042	2490612042	45/50(3,8)	4,8	200		50	9,8
2491613042	2490613042	45/50(3,8)	4,8	300		50	12,7
2491614042	2490614042	45/50(3,8)	4,8	400		50	15,6



Mindestbestellmenge 1000 Stück je Sorte / minimum order quantity 1000 pieces  
 Quantité minimale de commande: 1000 pièces / cantidad mínima por pedido: 1000 unidades

## Doppelhaken mit Etikettenträger und Metallfahne 40 x 30 mm verzinkt

Double hook with label holder and metal price flag 40 x 30 mm zinc  
 Gancho doble con porta-etiquetas y portaprecio metálico 40 x 30 mm zincado  
 Crochet double avec bras porte-prix et étiquette métallique 40 x 30 mm zingué



15	25	mm	mm	mm	mm	kg
2491602042	2490602042	45/50(3,8)	4,8	200	50	12,3
2491603042	2490603042	45/50(3,8)	4,8	300	50	18,6
2491604042	2490604042	45/50(3,8)	4,8	400	50	24,9

Artikel nur auf Anfrage erhältlich / only on request / uniquement sur demande / solamente a pedido

## Doppelhaken mit Klappverschluss und Metallfahne 28 x 28 mm verzinkt

Double hook with locking device and metal price flag 28 x 28 mm zinc  
 Gancho doble con cierre basculante y portaprecio metálico 28 x 28 mm zincado  
 Crochet double avec arrêt de sécurité et étiquette métallique 28 x 28 mm zingué



15	25	mm	mm	mm	mm	kg
310979204228	-	30	4,8	200	50	13,3
310979304228	-	30	4,8	300	50	16,4
310979404228	-	30	4,8	400	50	19,5

## Doppelhaken mit Klappverschluss und Metallfahne 28 x 52 mm verzinkt

Double hook with locking device and metal price flag 28 x 52 mm zinc  
 Gancho doble con cierre basculante y portaprecio metálico 28 x 52 mm zincado  
 Crochet double avec arrêt de sécurité et étiquette métallique 28 x 52 mm zingué



15	25	mm	mm	mm	mm	kg
310979204252	-	30	4,8	200	50	13,3
310979304252	-	30	4,8	300	50	16,4
310979404252	-	30	4,8	400	50	19,5

## Doppelhaken für Sysem-Steckplatte mit Metallfahne 52 x 28 mm verzinkt

Double hook for special system plate with metal price flag 52 x 28 mm zinc  
 Gancho doble para placa sistema con portaprecio metálico 52 x 28 mm zincado  
 Crochet double pour platine renforcée avec étiquette métallique 52 x 28 mm zingué



15	25	mm	mm	mm	mm	kg
241576204252	-	30	4,8	200	50	9,8
241576304252	-	30	4,8	300	50	12,4
241576404252	-	30	4,8	400	50	15,4

## System-Steckplatte verzinkt

System plate zinc  
Placa sistema zincado  
Platine renforcée zinguée

15	25	mm	mm			
2415490302	-	30	85		50	3,6



## Pendeltasche für Etikettenträger transparent

Clear plastic price label jacket to fit on label holder  
Funda de plástico transparente para etiqueta de precio  
Porte-étiquette plastique pour broche en T

		axb mm axc mm axb mm				
1250014426		44x26			50	0,3
1250002650		52x26			50	0,4
1250002656		56x26			50	0,4
1250002670		70x26			50	0,4



## Pendeltasche für Etikettenträger transparent

Clear plastic price label jacket to fit on label holder  
Funda de plástico transparente para etiqueta de precio  
Porte-étiquette plastique pour broche en T

		axb mm axc mm axb mm				
1250014040		40x40			50	0,4
1250014045		45x40			50	0,5
1250014500		52x40			50	0,6
1250014060		60x40			50	0,6
1250014070		70x40			50	0,6
1250014800		80x40			50	0,8
1250014900		90x40			50	1,0
12500140100		100x40			50	1,0
1250016500		105x40			50	1,1
1250016600		110x40			50	1,2



## Pendeltasche für Etikettenträger transparent

Clear plastic price label jacket to fit on label holder  
Funda de plástico transparente para etiqueta de precio  
Porte-étiquette plastique pour broche en T

		axb mm axc mm axb mm				
1250015237		37x52			50	0,6
1250015252		52x52			50	0,7
1250015260		60x52			50	0,7
1250015280		80x52			50	0,8







## Kunststoff-Fahne weiß mit Anlegesteg

Price flag made of white plastics

Porta-precio de plástico blanco

Etiquette en plastique blanche clipsable



				 mm	 $\frac{a \times b}{c \times d}$ mm		 kg
1240014000				<=4,8	27x40(52)	50	0,1





## Kunststoff-Fahne weiß ohne Anlegesteg

Price flag made of white plastics

Porta-precio de plástico blanco

Etiquette en plastique blanche clipsable



				 mm	 $\frac{a \times b}{c \times d}$ mm		 kg
1240015000				<=4,8	27x27(37)	50	0,1
1240524000				<=4,8	27x42(52)	50	0,1
1240014500				<=6,0	27x42(52)	50	0,1





## Kunststoff-Fahne transparent

Clear plastic price flag with flag window

Indicador de precios de plástico transparente con ventana

Etiquette en plastique transparent clipsable, avec fenêtre



				 mm	 $\frac{a \times b}{c \times d}$ mm		 kg
1240062626				<=4,8	26x26(50)	100	0,1
1240062642				<=4,8	26x42(60)	100	0,1





## Metallfahne zum Nachrüsten

Metal price flag

Portaprecio de metal





Etiquette en métal



				 mm	 $\frac{a \times b}{c \times d}$ mm		 kg
4000700200				4,8	17,5x25(33)	50	0,1
4000700400				3,8	25x25(37)	50	0,3
4000700300				4,8	25x25(37)	50	0,3

## Metallfahne zum Nachrüsten





Metal price flag  
Portaprecio de metal  
Etiquette en métal

					 28x28(35) 28x28(35) 28x28(35)		
4000510300				3,8	28x28(35)	50	0,4
4000520300				4,8	28x28(35)	50	0,4
4000510500				6,0	28x28(35)	50	0,4



## Metallfahne zum Nachrüsten



Metal price flag  
Portaprecio de metal  
Etiquette en métal

					 28x30(52) 28x30(52) 28x30(52)		
4000765000				3,8	28x30(52)	50	0,6
4000765200				4,8	28x30(52)	50	0,6
4000765500				6,0	28x30(52)	50	0,6



## Kunststoff-Adapter für Einfachhaken weiß





Adapter made of white plastics, for single hook  
Adaptador plástico blanco, para gancho simple  
Adaptateur en plastique blanc, pour crochet simple

							
1240013010				6,0		100	0,2
1240013040				7,0		100	0,2
1240013020				8,0		100	0,2
1240013030				10,0		100	0,2
1240013050				12,0		250	0,3



## Metall-Adapter mit Fahne für Einfachhaken

Metal adapter with price flag, for single hook  
Adaptador metálico con portaprecios, para gancho simple  
Adaptateur en métal, avec porte-étiquette, pour crochet simple

					 28x35 28x41 28x52		
400014-				-	28x35	-	-
400017-				-	28x41	-	-
400013-				-	28x52	-	-
-0510				3,8	-	100	0,8
-0610				4,8	-	100	0,9
-0310				6,0	-	100	0,9
-0210				7,0	-	100	0,9
-0410				8,0	-	100	0,9
-0010				10,0	-	100	1,0
-0110				12,0	-	100	1,0







## Kunststoff-Klemmstopper für Einfachhaken transparent

Stopper made of clear plastics, suitable for single hook

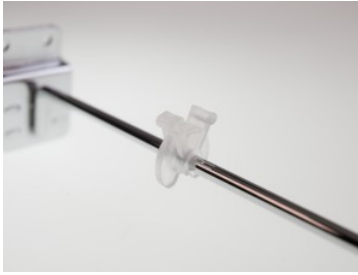
Tope de plástico para gancho simple

Limiteur de stock en plastique, pour crochet simple



							
1202000400				4,8	transparent	100	0,2
1202000600				6,0	transparent	100	0,2
1202000800				8,0	transparent	100	0,2
1202001000				10,0	transparent	100	0,2





## Kunststoff-Klemmstopper für Einfachhaken

Stopper made of clear plastics, suitable for single hook

Tope de plástico para gancho simple

Limiteur de stock en plastique, pour crochet simple



							
1202000200				4,0-4,8	transparent	200	0,2
1202000100				4,0-4,8	RAL9005	200	0,2



## Metall-Klemmstopper für Doppelhaken

Stopper made of metal, suitable for double hook

Tapón de metal para ganchos doble

Limiteur de stock en métal, pour broche double



							
2402000100				2,5-6,0		50	0,3



## Kunststoff-Schloss transparent

Lock for hooks made of clear plastic

Bloqueo para gancho plástico transparente

Serrure en plastique transparent





							
1300400500				>=4,8		50	1,0

Wir biegen Lösungen

## Kunststoff-Schloss weiß





Lock for hooks made of white plastic  
 Bloqueo para gancho plástico blanco  
 Serrure en plastique blanc

				 mm			 kg
1300400400				>=4,8		50	1,0



## Kunststoff-Schloss mit Schließzylinder





Lock made of plastics (with metal cylinder lock)  
 Cerradura de plástico (cierre metálico)  
 Serrure en plastique (barillet en métal)

				 mm			 kg
1300100200				>=4,8	transparent	50	3,8



## Kunststoff-Kappen für Einfachhaken schwarz und weiß

Rubber cap, black and white colour, suitable for single hook  
 Casquillo de goma, blanco o negro, para gancho simple  
 Capuchon plastique, noir et blanc, pour crochet simple

		 mm				 kg
1201003420		3,4		RAL9005	100	0,1
1201004020		4,0		RAL9005	100	0,1
1201004820		4,8		RAL9005	100	0,1
1201006020		6,0		RAL9005	100	0,1
1201008020		8,0		RAL9005	100	0,2
1201010020		10,0		RAL9005	100	0,2
1201003410		3,4		RAL9001	100	0,1
1201004010		4,0		RAL9001	100	0,1
1201004810		4,8		RAL9001	100	0,1
1201006010		6,0		RAL9001	100	0,1
1201008010		8,0		RAL9001	100	0,2
1201010010		10,0		RAL9001	100	0,2





# HOHAGE

Wir biegen Lösungen

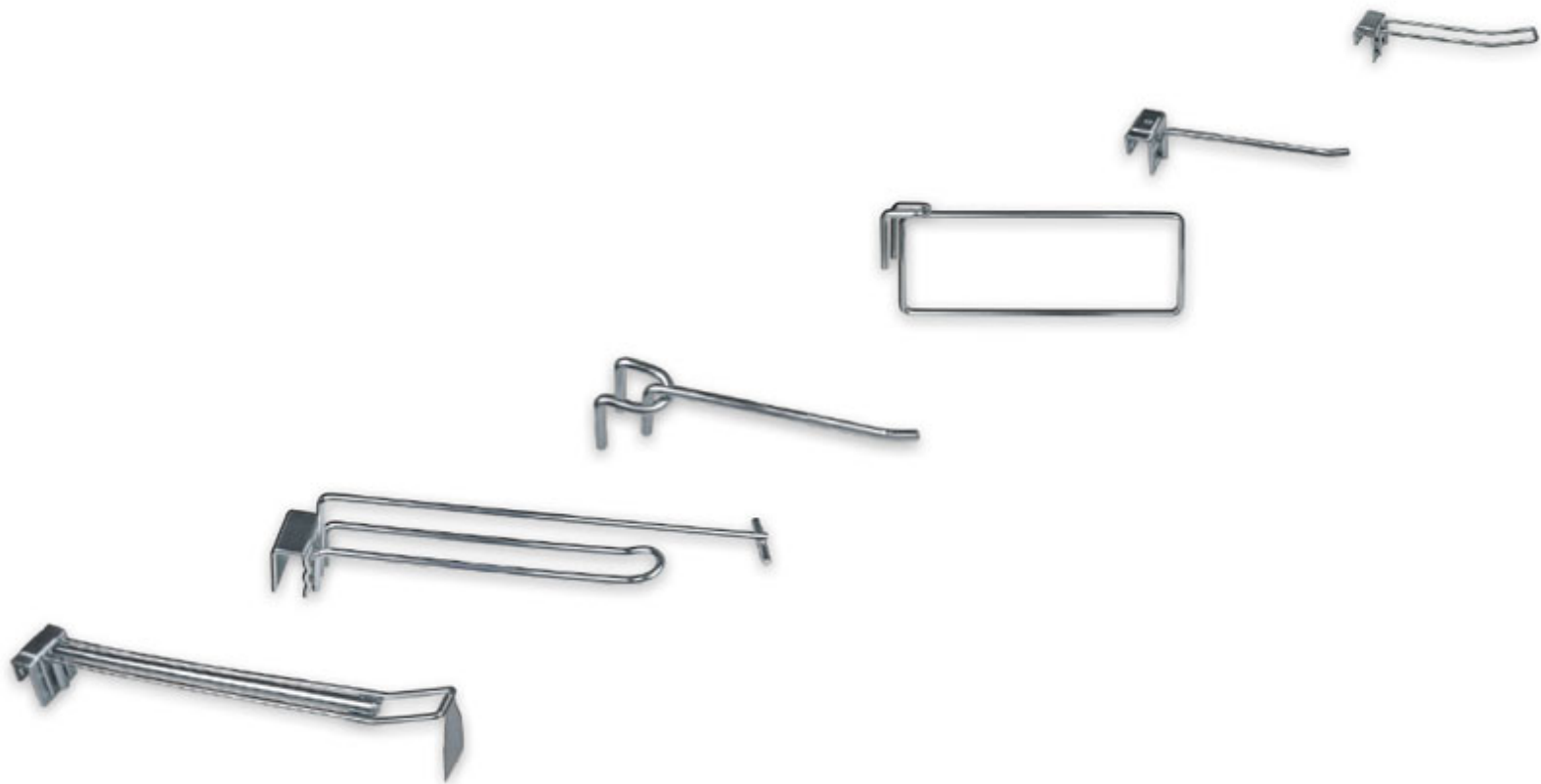

# 4





## Haken für Trageschiene

Hooks for bar systems  
Ganchos para sistema de barra  
Crochets pour barres

## Krallenhaken übergreifend für Trageschiene 20 mm verzinkt

Bar hook heavy type for rear support bar 20 mm zinc  
 Gancho de barra tipo pesado para barra 20 mm zincado  
 Crochet à poser sur barre de 20 mm zingué







				 mm	 mm		 kg
2491402010	20			8,0	200	50	19,4
2491403010	20			8,0	300	25	23,2
2491404010	20			8,0	400	25	27,0
2491405010	20			8,0	500	25	30,2

## Krallenhaken übergreifend für Trageschiene 20 mm verzinkt

Bar hook heavy type for rear support bar 20 mm zinc  
 Gancho de barra tipo pesado para barra 20 mm zincado  
 Crochet à poser sur barre de 20 mm zingué







				 mm	 mm		 kg
2491413010	20			10,0	300	25	32,0
2491414010	20			10,0	400	25	38,5
2491415010	20			10,0	500	25	45,0
2491423010	20			12,0	300	25	42,9
2491424010	20			12,0	400	25	51,9
2491425010	20			12,0	500	25	61,0

## Krallenhaken eingreifend für Trageschiene 20 mm verzinkt

Bar hook heavy type suitable for hanging into rear support bar 20 mm zinc  
 Gancho de barra tipo pesado para colgar en barra 20 mm zincado  
 Crochet à poser dans barre de 20 mm zingué



				 mm	 mm		 kg
2491402110	20			8,0	200	50	19,4
2491403110	20			8,0	300	25	23,4
2491404110	20			8,0	400	25	26,0
2491405110	20			8,0	500	25	29,8

## Krallenhaken eingreifend für Trageschiene 20 mm verzinkt

Bar hook heavy type suitable for hanging into rear support bar 20 mm zinc  
 Gancho de barra tipo pesado para colgar en barra 20 mm zincado  
 Crochet à poser dans barre de 20 mm zingué



				 mm	 mm		 kg
2491413110	20			10,0	300	25	32,0
2491414110	20			10,0	400	25	38,5
2491415110	20			10,0	500	25	44,7
2491423110*	20			12,0	300	25	42,9
2491424110*	20			12,0	400	25	51,9
2491425110*	20			12,0	500	25	61,0

\* Mindestbestellmenge 1000 Stück je Sorte / minimum order quantity 1000 pieces

\* Quantité minimale de commande: 1000 pièces / cantidad mínima por pedido: 1000 unidades

## Krallenhaken übergreifend mit Etikettenträger für Trageschiene 20 mm verzinkt

Bar hook heavy type with top label holder for rear support bar 20 mm zinc  
 Gancho de barra tipo pesado con soporte de etiqueta para barra 20 mm zincado  
 Crochet à poser sur barre de 20 mm avec bras porte-prix zingué

	20		mm		mm	50	kg
6091402010	20		8,0		200	50	21,0
6091403010	20		8,0		300	25	26,1
6091404010	20		8,0		400	25	31,2
6091405010	20		8,0		500	25	33,0



Die passenden Pendeltaschen finden Sie auf der Seite 35.

## Krallenhaken übergreifend mit Etikettenträger für Trageschiene 20 mm verzinkt

Bar hook heavy type with top label holder for rear support bar 20 mm zinc  
 Gancho de barra tipo pesado con soporte de etiqueta para barra 20 mm zincado  
 Crochet à poser sur barre de 20 mm avec bras porte-prix zingué

	20		mm		mm	25	kg
6091413010	20		10,0		300	25	32,0
6091414010	20		10,0		400	25	40,7
6091415010	20		10,0		500	25	42,0
6091424010	20		12,0		400	25	58,0
6091425010	20		12,0		500	25	66,6



Die passenden Pendeltaschen finden Sie auf der Seite 35.

## Trennbügel für gelochte Trageschiene 20 mm

Separator for rear support bar with holes 20 mm  
 Separador para colgar en la barra de apoyo trasera con agujeros 20 mm  
 Séparateur pour barre avec trous de 20 mm

	20		mm	mm		20	kg
5 4070 24	20		7,0	320	juraweiß	20	34,0
5 5043 24	20		7,0	420	juraweiß	20	38,2
5 5043 37	20		7,0	420	verzinkt	20	38,2



## Universal-Trennbügel für gelochte Trageschiene 20 mm verzinkt

Universal-separator for rear support bar with holes 20 mm zinc  
 Separador universal para colgar en barra de apoyo trasera con agujeros 20 mm zincado  
 Séparateur pour barre avec trous de 20 mm zingué

	20		mm	mm	5	kg
3005620310	20		8,0	200	5	24,0
3005620110	20		8,0	420	5	50,0







## Aufsteck-Einfachhaken für Trageschiene 15 mm verzinkt

Single hook for rear support bar 15 mm zinc

Gancho simple para barra 15 mm zincado

Crochet simple pour barre de 15 mm zingué



				 mm	 mm		 kg
2440681510	15			4,8	150	50	11,2
2440682010	15			4,8	200	50	12,6
2440682510	15			4,8	250	50	14,0
2440683010	15			4,8	300	50	15,4
2440684010	15			4,8	400	50	16,6





## Aufsteck-Einfachhaken für Trageschiene 20 mm verzinkt

Single hook for rear support bar 20 mm zinc

Gancho simple para barra 20 mm zincado

Crochet simple pour barre de 20 mm zingué



				 mm	 mm		 kg
2441681510	20			4,8	150	50	11,2
2441682010	20			4,8	200	50	12,6
2441682510	20			4,8	250	50	14,0
2441683010	20			4,8	300	50	15,4
2441684010	20			4,8	400	50	16,6





## Aufsteck-Einfachhaken für Trageschiene 15 mm verzinkt

Single hook for rear support bar 15 mm zinc

Gancho simple para barra 15 mm zincado

Crochet simple pour barre de 15 mm zingué



				 mm	 mm		 kg
2440672510	15			8,0	250	50	19,4
2440673010	15			8,0	300	50	22,4
2440674010	15			8,0	400	50	27,1





## Aufsteck-Einfachhaken für Trageschiene 20 mm verzinkt

Single hook for rear support bar 20 mm zinc

Gancho simple para barra 20 mm zincado

Crochet simple pour barre de 20 mm zingué



				 mm	 mm		 kg
2441672510	20			8,0	250	50	19,4
2441673010	20			8,0	300	50	22,4
2441674010	20			8,0	400	50	27,1

## Aufsteck-Einfachhaken mit Etikettenträger für Trageschiene 15 mm verzinkt

Single hook with top label holder for rear support bar 15 mm zinc  
 Gancho simple con soporte de etiqueta superior para barra 15 mm zincado  
 Crochet simple avec bras porte-prix pour barre de 15 mm zingué

6040681510	15			4,8	150	50	13,2
6040682010	15			4,8	200	50	14,6
6040682510	15			4,8	250	50	16,0
6040683010	15			4,8	300	50	17,4
6040684010	15			4,8	400	50	18,6



Die passenden Pendeltaschen finden Sie auf der Seite 35.

## Aufsteck-Einfachhaken mit Etikettenträger für Trageschiene 20 mm verzinkt

Single hook with top label holder for rear support bar 20 mm zinc  
 Gancho simple con soporte de etiqueta superior para barra 20 mm zincado  
 Crochet simple avec bras porte-prix pour barre de 20 mm zingué

6041681510	20			4,8	150	50	13,2
6041682010	20			4,8	200	50	14,6
6041682510	20			4,8	250	50	16,0
6041683010	20			4,8	300	50	17,4
6041684010	20			4,8	400	50	18,6



Die passenden Pendeltaschen finden Sie auf der Seite 35.

## Aufsteck-Einfachhaken mit Etikettenträger für Trageschiene 15 mm verzinkt

Single hook with top label holder for rear support bar 15 mm zinc  
 Gancho simple con soporte de etiqueta superior para barra 15 mm zincado  
 Crochet simple avec bras porte-prix pour barre de 15 mm zingué

6040672510	15			8,0	250	50	21,4
6040673010	15			8,0	300	50	24,4
6040674010	15			8,0	400	50	29,1



Die passenden Pendeltaschen finden Sie auf der Seite 35.

## Aufsteck-Einfachhaken mit Etikettenträger für Trageschiene 20 mm verzinkt

Single hook with top label holder for rear support bar 20 mm zinc  
 Gancho simple con soporte de etiqueta superior para barra 20 mm zincado  
 Crochet simple avec bras porte-prix pour barre de 20 mm zingué

6041672510	20			8,0	250	50	21,4
6041673010	20			8,0	300	50	24,4
6041674010	20			8,0	400	50	29,1







Die passenden Pendeltaschen finden Sie auf der Seite 35.

## Aufsteck-Einfachhaken für Trageschiene 20 mm verzinkt

Single hook suitable for rear support bar 20 mm zinc  
 Gancho simple para barra 20 mm de espesor zincado  
 Crochet simple emboîtable pour barre de 20 mm zingué







							
	mm			mm	mm		kg
5 3802 37	20			7,0	200	50	17,1
5 3804 37	20			7,0	250	50	19,4
5 3806 37	20			7,0	300	50	22,7
5 3808 37	20			10,0	400	50	37,8

## Aufsteck-Einfachhaken für gelochte Trageschiene 20 mm verzinkt

Single hook suitable for rear support bar 20 mm with holes zinc  
 Gancho simple para barra de apoyo de 20 mm de espesor trasera con agujeros zincado  
 Crochet simple emboîtable pour barre de 20 mm avec trous zingué







							
	mm			mm	mm		kg
5 1889 37	20			7,0	200	50	17,1
5 1890 37	20			7,0	250	50	19,4
5 1891 37	20			7,0	300	50	23,7
5 1439 37	20			10,0	400	50	37,5
5 1433 37	20			10,0	450	25	43,4

## Aufsteck-Einfachhaken mit Platte für gelochte Trageschiene 20 mm verzinkt

Single hook with end plate for rear support bar 20 mm with holes zinc  
 Gancho simple con placa final para barra 20 mm de espesor trasera con agujeros zincado  
 Crochet simple avec plaque ronde pour barre de 20 mm avec trous zingué







							
	mm			mm	mm		kg
5 1532 37	20			10,0	250	25	37,5
5 1579 37	20			10,0	400	25	43,4
5 1535 37	20			12,0	450	25	45,6

Artikel nur auf Anfrage erhältlich / only on request / uniquement sur demande / solamente a pedido

## Aufsteck-Doppelhaken für Trageschiene 20 mm verzinkt





Double hook for rear support bar 20 mm zinc  
 Gancho doble para barra 20 mm zincado  
 Crochet double emboîtable pour barre de 20 mm zingué



							
	mm			mm	mm		kg
5 3842 37	20			4,8	200	50	17,3
5 3844 37	20			4,8	300	50	20,3
5 3846 37	20			4,8	400	50	23,3

## Aufsteck-Doppelhaken für Trageschiene 15 mm verzinkt





Double hook for rear support bar 15 mm zinc  
Gancho doble para barra 15 mm zincado  
Crochet double pour barre de 15 mm zingué

							
	15			mm	mm		kg
2492111510	15			4,8	150	50	13,6
2492112010	15			4,8	200	50	15,4
2492112510	15			4,8	250	50	17,2
2492113010	15			4,8	300	50	19,0
2492114010	15			4,8	400	50	22,6



## Aufsteck-Doppelhaken für Trageschiene 20 mm verzinkt





Double hook for rear support bar 20 mm zinc  
Gancho doble para barra 20 mm zincado  
Crochet double pour barre de 20 mm zingué

							
	20			mm	mm		kg
2491111510	20			4,8	150	50	13,6
2491112010	20			4,8	200	50	15,4
2491112510	20			4,8	250	50	17,2
2491113010	20			4,8	300	50	19,0
2491114010	20			4,8	400	50	22,6



## Aufsteck-Doppelhaken mit Etikettenträger für Trageschiene 15 mm verzinkt

Double hook with top label holder for rear support bar 15 mm zinc  
Gancho doble con soporte de etiqueta superior para barra 15 mm zincado  
Crochet double avec bras porte-prix pour barre de 15 mm zingué





							
	15			mm	mm		kg
6092111510	15			4,8	150	50	15,6
6092112010	15			4,8	200	50	17,4
6092112510	15			4,8	250	50	19,2
6092113010	15			4,8	300	50	21,0
6092114010	15			4,8	400	50	24,6



Die passenden Pendeltaschen finden Sie auf der Seite 35.

## Aufsteck-Doppelhaken mit Etikettenträger für Trageschiene 20 mm verzinkt

Double hook with top label holder for rear support bar 20 mm zinc  
Gancho doble con soporte de etiqueta superior para barra 20 mm zincado  
Crochet double avec bras porte-prix pour barre de 20 mm zingué

							
	20			mm	mm		kg
6091111510	20			4,8	150	50	15,6
6091112010	20			4,8	200	50	17,4
6091112510	20			4,8	250	50	19,2
6091113010	20			4,8	300	50	21,0
6091114010	20			4,8	400	50	24,6



Die passenden Pendeltaschen finden Sie auf der Seite 35.







## Aufsteck-Einfachhaken für Trageschiene 15 mm verzinkt

Single hook for rear support bar 15 mm zinc

Gancho simple para barra 15 mm zincado

Crochet simple pour barre de 15 mm zingué



						
3892192010	15		4,8	200	50	12,6
3892193010	15		4,8	300	50	15,4
3892194010	15		4,8	400	50	16,6





## Aufsteck-Einfachhaken mit Etikettenträger für Trageschiene 15 mm verzinkt

Single hook with top label holder for rear support bar 15 mm zinc

Gancho simple con soporte de etiqueta superior para barra 15 mm zincado

Crochet simple avec bras porte-prix pour barre de 15 mm zingué



						
6092192010	15		4,8	200	50	14,6
6092193010	15		4,8	300	50	17,4
6092194010	15		4,8	400	50	18,6

Die passenden Pendeltaschen finden Sie auf der Seite 35.





## Aufsteck-Doppelhaken für Trageschiene 15 mm verzinkt

Double hook for rear support bar 15 mm zinc

Gancho doble para barra 15 mm zincado

Crochet double pour barre de 15 mm zingué



						
3892111510	15		4,8	150	50	13,6
3892112010	15		4,8	200	50	15,4
3892112510	15		4,8	250	50	17,2
3892113010	15		4,8	300	50	19,0
3892114010	15		4,8	400	50	22,6





## Aufsteck-Doppelhaken mit Etikettenträger für Trageschiene 15 mm verzinkt

Double hook with top label holder for rear support bar 15 mm zinc

Gancho doble con soporte de etiqueta superior para barra 15 mm zincado

Crochet double avec bras porte-prix pour barre de 15 mm zingué







						
6892111510	15		4,8	150	50	15,6
6892112010	15		4,8	200	50	17,4
6892112510	15		4,8	250	50	19,2
6892113010	15		4,8	300	50	21,0
6892114010	15		4,8	400	50	24,6

Die passenden Pendeltaschen finden Sie auf der Seite 35.

## Aufsteck-Schwerlasthaken für Trageschiene 20 mm verzinkt

Triple hook heavy type for rear support bar 20 mm zinc  
 Gancho triple tipo pesado para barra 20 mm zincado  
 Crochet triple emboîtable pour barre de 20 mm zingué





							
2492223010	20		4,0/10,0	300		25	46,0
2492224010	20		4,0/10,0	400		25	48,5
2492225010	20		4,0/10,0	500		25	51,0



Mindestbestellmenge 500 Stück je Sorte / minimum order quantity 500 pieces  
 Quantité minimale de commande: 500 pièces / cantidad mínima por pedido: 500 unidades

## Aufsteck-Schwerlasthaken mit Metallfahne für Trageschiene 20 mm verzinkt

Triple hook heavy with metal price flag for rear support bar 20 mm zinc  
 Gancho triple tipo pesado con bandera de precios metálica para barra 20 mm zincado  
 Crochet triple avec étiquette métallique porte-prix pour barre de 20 mm zingué





							
249222301028	20		4,0/10,0	300	28x28(35)	25	46,5
249222401028	20		4,0/10,0	400	28x28(35)	25	49,0
249222501028	20		4,0/10,0	500	28x28(35)	25	54,5



Mindestbestellmenge 500 Stück je Sorte / minimum order quantity 500 pieces  
 Quantité minimale de commande: 500 pièces / cantidad mínima por pedido: 500 unidades

## Aufsteck-Schwerlasthaken mit Metallfahne für Trageschiene 20 mm verzinkt

Triple hook heavy type with metal price flag for rear support bar 20 mm zinc  
 Gancho triple tipo pesado con bandera de precios metálica para barra 20 mm zincado  
 Crochet triple avec étiquette métallique porte-prix pour barre de 20 mm zingué





							
249222301052	20		4,0/10,0	300	28x30(52)	25	46,5
249222401052	20		4,0/10,0	400	28x30(52)	25	49,0
249222501052	20		4,0/10,0	500	28x30(52)	25	54,5



Mindestbestellmenge 500 Stück je Sorte / minimum order quantity 500 pieces  
 Quantité minimale de commande: 500 pièces / cantidad mínima por pedido: 500 unidades

## Aufsteck-Schwerlasthaken mit Etikettenträger für Trageschiene 20 mm verzinkt

Triple hook heavy type with top label holder suitable for rear support bar 20 mm zinc  
 Gancho triple tipo pesado con soporte de etiqueta superior para barra 20 mm zincado  
 Crochet triple avec bras porte-prix pour barre de 20 mm zingué

							
6092223010	20		4,0/10,0	300		25	52,5
6092224010	20		4,0/10,0	400		25	58,7
6092225010	20		4,0/10,0	500		25	64,9







Mindestbestellmenge 500 Stück je Sorte / minimum order quantity 500 pieces  
 Quantité minimale de commande: 500 pièces / cantidad mínima por pedido: 500 unidades  
 Die passenden Pendeltaschen finden Sie auf der Seite 35.

## Trageschiene aus Vierkantrohr 50 x 20 mm gelocht

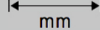
Support bar made of square tube 50 x 20 mm with holes  
 Barra de carga, tubo cuadrado 50 x 20 mm con agujeros  
 Barre de charge en tube carré 50 x 20 mm avec trous







							
	20			mm			kg
8050040665	20			665	RAL 7035	1	111,0
8050041000	20			1000	RAL 7035	1	145,0
8050041250	20			1250	RAL 7035	1	181,0
8050050665	20			665	RAL 9006	1	111,0
8050051000	20			1000	RAL 9006	1	145,0
8050051250	20			1250	RAL 9006	1	181,0
8050060665	20			665	RAL 9001	1	111,0
8050061000	20			1000	RAL 9001	1	145,0
8050061250	20			1250	RAL 9001	1	181,0

## Trageschiene aus Vierkantrohr 50 x 20 mm ungelocht

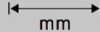
Support bar made of square tube 50 x 20 mm without holes  
 Barra de carga, tubo cuadrado 50 x 20 mm sin perforaciones  
 Barre de charge en tube carré 50 x 20 mm sans trous



							
	20			mm			kg
1250251000	20			1000	RAL 9010	1	150,0
1250251250	20			1250	RAL 9010	1	185,0



# HOHAGE

Wir biegen Lösungen

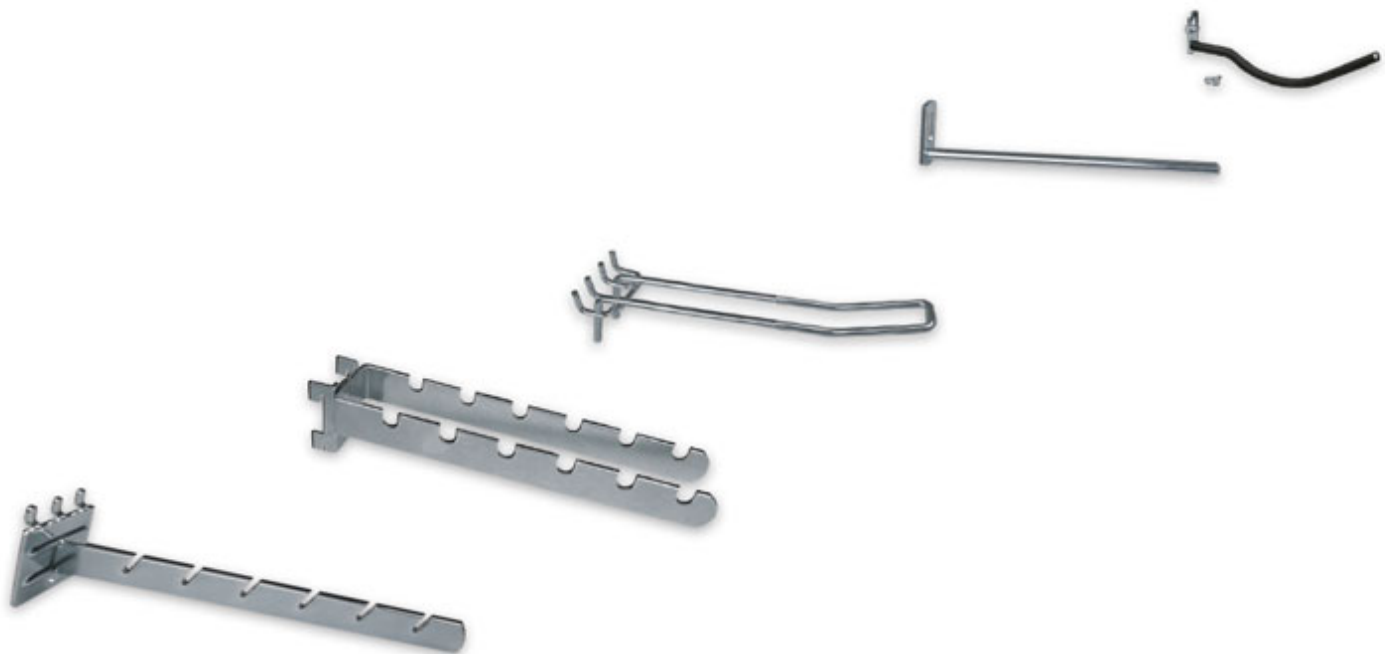

# HOHAGE

---

Wir biegen Lösungen

5

## Sonderhaken Werkzeuge

Special hooks for tools

Ganchos especiales para herramientas

Crochets spéciaux pour outils

## Einfach-Kellenhalter mit Einhängelplatte verzinkt

Single trowel holder with plate zinc

Soporte simple paletas con placa zincado

Support simple pour truelle, avec platine zingué



15	mm	mm	mm	mm			kg
2493410110	30		20x3	235		25	13,8

## Einfach-Kellenhalter mit Einhängelplatte und Fahnenhalter verzinkt

Single trowel holder with plate and price flag holder zinc

Soporte simple paletas con placa y soporte portaprecios zincado

Support simple pour truelle, platine, avec porte-étiquette zingué



15	mm	mm	mm	mm			kg
2493410110FH	30		20x3	235		25	14,0

## Einfach-Kellenhalter mit Einhängelplatte, Fahnenhalter und Metallfahne verzinkt

Single trowel holder with plate and metal price flag zinc

Soporte simple paletas con placa y soporte portaprecios zincado

Support simple pour truelle, platine, avec porte-étiquette et étiquette métallique attachée zingué



15	mm	mm	mm	mm	a-b mm c-d mm e-f mm		kg
249341011028	30		20x3	235	28x28(35)	25	14,6

## Einfach-Kellenhalter mit Einhängelplatte, Fahnenhalter und Metallfahne verzinkt

Single trowel holder with plate and metal price flag zinc

Soporte simple paletas con placa y soporte portaprecios zincado







Support simple pour truelle, platine, avec porte-étiquette et étiquette métallique attachée zingué

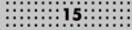

15	mm	mm	mm	mm	a-b mm c-d mm e-f mm		kg
249341011052	30		20x3	235	28x30(52)	25	14,6

## Doppel-Kellenhalter mit Einhängeplatte verzinkt







Double trowel holder with plate zinc  
 Soporte doble paletas con placa zincado  
 Support double pour truelle, avec platine zingué

					
2493420110	30	20x3	235	25	23,7



## Doppel-Kellenhalter mit Einhängeplatte und Fahnenhalter verzinkt







Double trowel holder with plate and price flag holder zinc  
 Soporte doble paletas con placa y soporte portaprecios zincado  
 Support double pour truelle, platine, avec porte-étiquette zingué

					
2493420110FH	30	20x3	235	25	24,0



## Doppel-Kellenhalter mit Einhängeplatte, Fahnenhalter und Metallfahne verzinkt







Double trowel holder with plate and holder with metal price flag zinc  
 Soporte doble paletas con placa y soporte portaprecios zincado  
 Support double pour truelle, platine, avec porte-étiquette et étiquette métallique attachée zingué

						
249342011028	30	20x3	235	28x28(35)	25	25,1

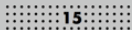

## Doppel-Kellenhalter mit Einhängeplatte, Fahnenhalter und Metallfahne verzinkt

Double trowel holder with plate and holder with metal price flag zinc  
 Soporte doble paletas con placa y soporte portaprecios zincado  
 Support double pour truelle, platine, avec porte-étiquette et étiquette métallique attachée zingué

						
249342011052	30	20x3	235	28x30(52)	25	25,1





## Doppelhaken für Rückwand mit Schlüssellochung verzinkt

Suspension hook for back panel with key holes zinc

Gancho de suspensión para paneles traseros perforados llave zincado

Crochet double pour fond à perforation clés zingué



Part Number	mm	mm	mm	kg
3 6432 37	4,8	200	50	13,8
3 6434 37	4,8	300	50	15,9

Artikel nur auf Anfrage erhältlich / only on request / uniquement sur demande / solamente a pedido

## Gerätehalter für Rückwand mit Schlüssellochung verzinkt

Tool holder for back panel with key holes zinc

Soporte herramienta para paneles traseros perforados llave zincado

Support outils pour fond à perforation clés zingué



Part Number	mm	mm	mm	kg
3 6754 37	300	60	10	86,1

Artikel nur auf Anfrage erhältlich / only on request / uniquement sur demande / solamente a pedido

## Displayhalter 500 - 1000 mm teleskopierbar verzinkt

Display holder telescopic 500 - 1000 mm zinc

Soporte expositor telescópico 500 - 1000 mm zincado

Porte-display extensible 500 - 1000 mm zingué



Part Number	mm	mm	mm	kg
3040550110	12,0/7,0	500-1000	1	23,6
3040540110	12,0/7,0	500-1000	1	23,6

Mindestbestellmenge 500 Stück je Sorte / minimum order quantity 500 pieces  
Quantité minimale de commande: 500 pièces / cantidad mínima por pedido: 500 unidades

## Werkzeughalter verzinkt

Hammer holder zinc

Soporte martillo zincado

Porte-marteau zingué



Part Number	mm	mm	mm	mm	mm	kg	
3040300510	-	-	45	6,0	220	10	51,2
-	3040300110	20	-	6,0	220	10	63,6

Mindestbestellmenge 500 Stück je Sorte / minimum order quantity 500 pieces  
Quantité minimale de commande: 500 pièces / cantidad mínima por pedido: 500 unidades

## Gerätehalter für Trageschiene 20 mm, Breite 60 mm verzinkt

Tool holder for rear support bar 20 mm, width 60 mm zinc

Soporte herramienta para barra de carga trasera 20 mm, ancho 60 mm zincado

Support outils pour barre de charge 20 mm, largeur 60 mm zingué

					
5 3686 37	20	300	60	10	51,2
5 3685 37*	20	480	60	10	63,6

\* Mindestbestellmenge 500 Stück / minimum order quantity 500 pieces  
 \* Quantité minimale de commande: 500 pièces / cantidad mínima por pedido: 500 unidades







## Spatenhalter gewellt für 8 Spaten mit Schild 60 x 30 mm für Trageschiene 20 mm verzinkt

Corrugated holder for spades, suitable for 8 spades, with plate 60 x 30 mm for rear support bar 20 mm zinc

Soporte corrugado para palas, apto para 8 palas con placa 60 x 30 mm zincado

Porte-bêche ondulée pour 8 bêches, avec plaque 60 x 30 mm zingué

					
3010470310	20	10,0	400	1	70,6



## Werkzeughalter mit Gummischlauch inklusive Schraube und Spezialmutter verzinkt

Holder with rubber for tools with screw and special nut zinc  
 Soporte herramienta con goma para taladro, con tornillo y tuerca especial zincado  
 Porte-outil et perceuse, avec enrobage en caoutchouc, avec vis et écrou spécial zingué



Part Number	mm	mm	mm	mm	mm	kg
3 6420 37	9,0	180	50			10,7

## Schraube und Spezialmutter für Rückwand mit Schlüssellochung verzinkt

Screw with special nut for back panel with key holes zinc  
 Tornillo con tuerca especial para el panel trasero con perforado llave zincado  
 Vis et écrous spéciaux pour fond à perforation clés zingués



Part Number	kg
6 3905 37 V	0,6

## Werkzeughalter inklusive Schraube und Spezialmutter verzinkt

Holder for tools with screw and special nut zinc  
 Soporte herramienta, con tornillo y tuerca especial zincado  
 Porte-outil et perceuse, avec vis et écrou spécial zingué



Part Number	mm	mm	mm	mm	kg
3 6400 37*	7,0	90	50		4,1
3 6405 37	9,0	90	50		4,7

\* ohne Gummischlauch / without rubber / sin goma / sans enrobage en caoutchouc

## Displayhalter zum Anschrauben mit L-Profil verzinkt

Display holder to screw on, with L-profile zinc  
 Soporte expositor para atornillar, con perfil "L" zincado  
 Porte-display à visser avec profil "L" zingué



Part Number	mm	mm	mm	kg
4000862010	7,0	200	50	4,2
4000863010	7,0	300	50	7,2
4000864010	7,0	400	50	10,2

Mindestbestellmenge 500 Stück je Sorte / minimum order quantity 500 pieces  
 Quantité minimale de commande: 500 pièces / cantidad mínima por pedido: 500 unidades

## Dornhaken mit Gummischlauch zum Anschrauben verzinkt

Tool holder with rubber to screw on zinc  
 Portaherramientas con goma para atornillar zincado  
 Broche à visser, avec enrobage en caoutchouc zinguée

15:				mm	mm		kg
9734-090100A				9,0/7,0	100	50	4,8
9734-090200A				9,0/7,0	200	50	7,6
9734-090300A				9,0/7,0	300	50	10,2



## Dornhaken mit Gummischlauch inklusive Schraube und Spezialmutter verzinkt

Tool holder with rubber, with screw and special nut zinc  
 Soporte herramienta con goma, con tornillo y tuerca especial zincado  
 Broche avec enrobage en caoutchouc, avec vis et écrou spécial zinguée

				mm	mm		kg
3 6330 37				9,0/7,0	100	50	3,8
3 6332 37				9,0/7,0	200	50	7,6
3 6334 37				9,0/7,0	300	50	11,4



## Dornhaken zum Anschrauben verzinkt

Tool holder to screw on zinc  
 Soporte herramienta para atornillar zincado  
 Broche à visser zinguée

				mm	mm		kg
9738-040040A				4,0	40	50	1,7
9738-040060A				4,0	60	50	1,8
9738-040080A				4,0	80	50	1,9
9738-040120A				4,0	120	50	2,2
9738-040170A				4,0	170	50	2,7
9732-070100A				7,0	100	50	4,0
9732-070200A				7,0	200	50	7,1
9732-070300A				7,0	300	50	10,2



## Dornhaken inklusive Schraube und Spezialmutter verzinkt

Tool holder with screw and special nut zinc  
 Soporte herramienta con tornillo y tuerca especial zincado  
 Broche avec vis et écrou spécial zinguée

				mm	mm		kg
3 6300 37				4,0	40	50	1,0
3 6302 37				4,0	60	50	1,5
3 6304 37				4,0	80	50	2,0
3 6308 37				4,0	120	50	3,0
3 6313 37				4,0	170	50	4,3
3 6320 37				7,0	100	50	2,4
3 6322 37				7,0	200	50	4,7
3 6324 37				7,0	300	50	7,1



## Doppelhaken mit Einhängeplatte verzinkt

Double hook with plate zinc  
Gancho doble con placa zincado  
Crochet double avec platine zingué



15	25	mm	mm	mm			
2492591610	2492791610*	30/25	4,8	160		100	5,8
2492592010	2492792010*	30/25	4,8	200		100	9,6
2492593010	2492793010*	30/25	4,8	300		100	13,4

\* Artikel nur auf Anfrage erhältlich / only on request / uniquement sur demande / solamente a pedido

## Einfachhaken mit Einhängeplatte verzinkt

Single hook with plate zinc  
Gancho simple con placa zincado  
Crochet simple avec platine zingué



15	25	mm	mm	mm			
9315-034050A	-	15	3,4	50		50	1,0

## Schlüsselhaken mit Einhängeplatte verzinkt

Special key hook with plate zinc  
Gancho especial llave con placa zincado  
Crochet spécial de clés avec platine zingué



15	25	mm	mm	mm			
9316-034065A	-	15	3,4	65		50	1,2

Mindestbestellmenge 1000 Stück / minimum order quantity 1000 pieces  
Quantité minimale de commande: 1000 pièces / cantidad mínima por pedido: 1000 unidades

## Spatenhalter mit 6 Kerben und Klappverschluss verzinkt

Fast entry spade holder with 6 notches zinc  
Soporte acceso rapido con 6 muescas zincado  
Porte-bêche avec 6 rainures, et arrêt de sécurité zinguée



15		mm	mm	mm			
7501003210		75		320	105	10	76,4

Mindestbestellmenge 500 Stück / minimum order quantity 500 pieces  
Quantité minimale de commande: 500 pièces / cantidad mínima por pedido: 500 unidades

## Kellenhalter für Lochwand mit Fahnenhalter und Kunststoff-Fahne 40 mm verzinkt

Trowel holder for back panel with holes, with price flag holder and plastic flag 40 mm zinc

Soporte para paneles traseros perforados, con plástico portaprecios 40 mm zincado

Support truelle pour fond perforé, avec porte-étiquette et étiquette plastique 40 mm attachée zingué

15		mm	mm	mm		kg
4502003210		45	320	40	25	66,9
7502003210		75	320	70	10	69,8

Mindestbestellmenge 500 Stück je Sorte / minimum order quantity 500 pieces  
Quantité minimale de commande: 500 pièces / cantidad mínima por pedido: 500 unidades



## Halter schwenkbar zur Einhängung in 2 gelochte Trageschienen 20 mm verzinkt

Pivotable holder for hanging into 2 rear support bars with holes 20 mm zinc

Soporte pivotable, con 2 varillas de enganche, para soporte barras traseras de 20 mm perforadas zincado

Support pivotant à accrocher dans 2 barres de charge perforées 20 mm zingué

		mm	mm		kg
5 1339 37		20	550	50	40,6
5 1340 37		20	750	50	52,3

Artikel nur auf Anfrage erhältlich / only on request / uniquement sur demande / solamente a pedido

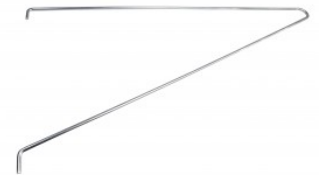

# HOHAGE

Wir biegen Lösungen

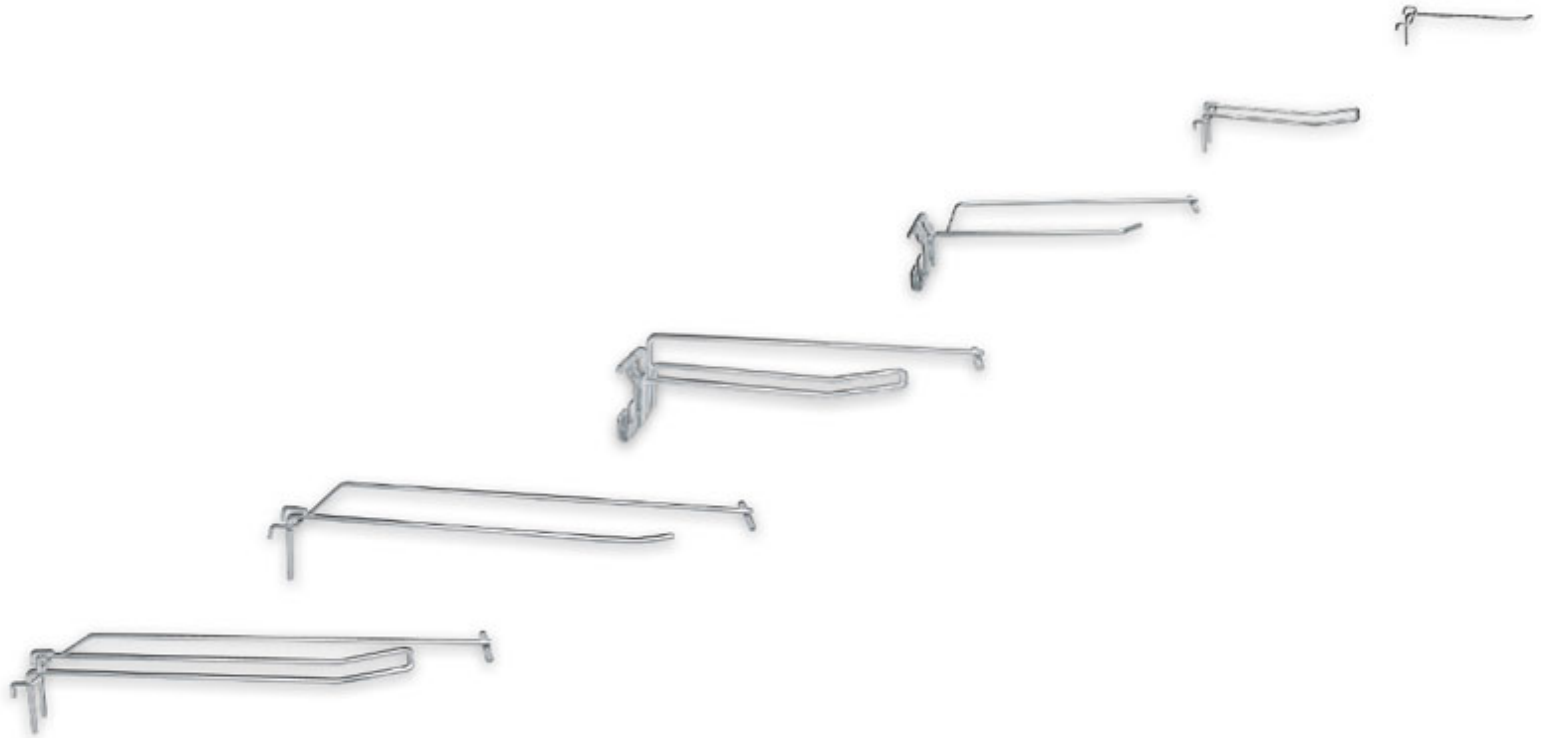

## **Gitterwandhaken**

Hooks for grid wall  
Ganchos para rejillas  
Crochets pour fond grillagé







## Gitterwand-Einfachhaken mit Brücke verzinkt

Single hook for grid wall with wire bridge zinc

Gancho simple para rejilla zincado

Crochet simple pour fond grillagé zingué



			 mm	 mm	 mm		 kg
2497541010			4,8	50	100	50	3,8
2497542010			4,8	50	200	50	5,0
2497543010			4,8	50	300	50	6,2

Mindestbestellmenge 500 Stück je Sorte / minimum order quantity 500 pieces  
Quantité minimale de commande: 500 pièces / cantidad mínima por pedido: 500 unidades

## Gitterwand-Einfachhaken mit Brücke und Etikettenträger verzinkt

Single hook for grid wall with wire bridge and top label holder zinc

Gancho simple para rejilla con soporte de etiqueta superior zincado

Crochet simple pour fond grillagé avec bras porte-prix zingué



			 mm	 mm	 mm		 kg
6092481010			4,8	50	100	50	4,7
6092482010			4,8	50	200	50	6,7
6092483010			4,8	50	300	50	8,7

Mindestbestellmenge 500 Stück je Sorte / minimum order quantity 500 pieces  
Quantité minimale de commande: 500 pièces / cantidad mínima por pedido: 500 unidades  
Die passenden Pendeltaschen finden Sie auf der Seite 35.

## Gitterwand-Einfachhaken mit Brücke verzinkt

Single hook for grid wall with wire bridge zinc

Gancho simple para rejilla zincado

Crochet simple pour fond grillagé zingué



			 mm	 mm	 mm		 kg
2497550510			4,8	40+50	50	50	4,2
2497551010			4,8	40+50	100	50	4,8
2497551510			4,8	40+50	150	50	6,9
2497552010			4,8	40+50	200	50	9,6

Mindestbestellmenge 500 Stück je Sorte / minimum order quantity 500 pieces  
Quantité minimale de commande: 500 pièces / cantidad mínima por pedido: 500 unidades

## Gitterwand-Einfachhaken mit Brücke und Etikettenträger verzinkt

Single hook for grid wall with wire bridge and top label holder zinc

Gancho simple para rejilla con soporte de etiqueta superior zincado

Crochet simple pour fond grillagé avec bras porte-prix zingué







			 mm	 mm	 mm		 kg
6097640510			4,0	80+90	50	50	4,5
6097641010			4,0	80+90	100	50	5,5
6097641510			4,0	80+90	150	50	7,8
6097642010			4,0	80+90	200	50	9,5

Mindestbestellmenge 500 Stück je Sorte / minimum order quantity 500 pieces  
Quantité minimale de commande: 500 pièces / cantidad mínima por pedido: 500 unidades  
Die passenden Pendeltaschen finden Sie auf der Seite 35.

## Gitterwand-Einfachhaken mit Lasche verzinkt

Single hook for grid wall with suspension plate zinc  
 Gancho simple para rejilla con placa colgante zincado  
 Crochet simple pour fond grillagé zingué







						
		mm	mm	mm		kg
2510611010		6,0	50	100	50	6,2
2510611510		6,0	50	150	50	9,3
2510612010		6,0	50	200	50	12,2
2510612510		6,0	50	250	50	15,1

Mindestbestellmenge 500 Stück je Sorte / minimum order quantity 500 pieces  
 Quantité minimale de commande: 500 pièces / cantidad mínima por pedido: 500 unidades



## Gitterwand-Einfachhaken mit Lasche für Kreuzbehang verzinkt

Single hook for grid wall with suspension plate for cross mesh zinc  
 Gancho simple para rejilla con placa colgante para malla metálica cruzada zincado  
 Crochet simple pour fond grillagé zingué

						
		mm	mm	mm		kg
2510421010		4,8	50	100	50	7,5
2510421510		4,8	50	150	50	11,3
2510422010		4,8	50	200	50	15,1
2510422510		4,8	50	250	50	19,2
2510423010		4,8	50	300	50	24,1

Mindestbestellmenge 500 Stück je Sorte / minimum order quantity 500 pieces  
 Quantité minimale de commande: 500 pièces / cantidad mínima por pedido: 500 unidades



## Gitterwand-Einfachhaken mit Lasche für Kreuzbehang und Etikettenträger verzinkt

Single hook for grid wall with suspension plate for cross mesh with top label holder zinc  
 Gancho simple para rejilla con placa colgante para malla metálica cruzada con soporte de etiqueta superior zincado  
 Crochet simple pour fond grillagé avec bras porte-prix zingué

						
		mm	mm	mm		kg
2510420110		4,8	50	100	50	8,0
2510420510		4,8	50	150	50	9,9
2510422110		4,8	50	200	50	11,8
2510422410		4,8	50	250	50	13,7
2510423110		4,8	50	300	50	15,6

Mindestbestellmenge 500 Stück je Sorte / minimum order quantity 500 pieces  
 Quantité minimale de commande: 500 pièces / cantidad mínima por pedido: 500 unidades  
 Die passenden Pendeltaschen finden Sie auf der Seite 35.







## Gitterwand-Doppelhaken mit Brücke verzinkt

Double hook for grid wall with wire bridge zinc

Gancho doble para rejilla con unión de alambre doblado hacia arriba zincado

Crochet double pour fond grillagé zingué



							
			mm	mm	mm		kg
2520121042			4,8	50	100	50	6,3
2520121542			4,8	50	150	50	7,4
2520120342			4,8	50	200	50	8,5
2520120142			4,8	50	300	50	10,3
2520120542			4,8	50	400	50	12,5





## Gitterwand-Doppelhaken mit Brücke und Etikettenträger verzinkt

Double hook for grid wall with wire bridge and top label holder zinc

Gancho doble para rejilla con unión de alambre doblado hacia arriba con soporte de etiqueta superior zincado

Crochet double pour fond grillagé avec bras porte-prix zingué



							
			mm	mm	mm		kg
6020121042			4,8	50	100	50	5,8
6020121542			4,8	50	150	50	7,8
6020122042			4,8	50	200	50	11,7
6020123042			4,8	50	300	50	15,6
6020124042			4,8	50	400	50	19,6

Mindestbestellmenge 500 Stück je Sorte / minimum order quantity 500 pieces

Quantité minimale de commande: 500 pièces / cantidad mínima por pedido: 500 unidades

Die passenden Pendeltaschen finden Sie auf der Seite 35.





## Gitterwand-Doppelhaken mit Brücke verzinkt

Double hook for grid wall with wire bridge zinc

Gancho doble para rejilla con pie de alambre doblado hacia arriba zincado

Crochet double pour fond grillagé zingué



							
			mm	mm	mm		kg
2497580510			4,8	50	50	50	5,8
2497581010			4,8	50	100	50	7,2
2497582010			4,8	50	200	50	10,0

Artikel nur auf Anfrage erhältlich / only on request / uniquement sur demande / solamente a pedido





## Gitterwand-Doppelhaken mit Brücke und Etikettenträger verzinkt

Double hook for grid wall with wire bridge and top label holder zinc

Gancho doble para rejilla con pie de alambre doblado hacia arriba con soporte de etiqueta superior zincado

Crochet double pour fond grillagé avec bras porte-prix zingué









							
			mm	mm	mm		kg
6097650510			4,0	80+90	50	50	7,3
6097651010			4,0	80+90	100	50	8,7
6097651510*			4,0	80+90	150	50	10,1
6097652010*			4,0	80+90	200	50	11,5

Artikel nur auf Anfrage erhältlich / only on request / uniquement sur demande / solamente a pedido

Die passenden Pendeltaschen finden Sie auf der Seite 35.

## Gitterwand-Doppelhaken mit Lasche verzinkt

Double hook for grid wall with suspension plate zinc  
 Gancho doble para rejilla con placa colgante zincado  
 Crochet double pour fond grillagé zingué







						
		mm	mm	mm		kg
2510551010		4,0	50	100	50	8,5
2510551510		4,0	50	150	50	9,0
2510552010		4,0	50	200	50	10,0

Artikel nur auf Anfrage erhältlich / only on request / uniquement sur demande / solamente a pedido



## Gitterwand-Doppelhaken mit Lasche für Kreuzbehang verzinkt

Double hook for grid wall with suspension plate for cross mesh zinc  
 Gancho doble para rejilla con placa colgante para malla metálica cruzada zincado  
 Crochet double pour fond grillagé zingué







						
		mm	mm	mm		kg
2510491510		4,8	50	150	50	11,0
2510492010		4,8	50	200	50	12,4
2510492510		4,8	50	250	50	13,8
2510493010		4,8	50	300	50	16,6

Artikel nur auf Anfrage erhältlich / only on request / uniquement sur demande / solamente a pedido



## Gitterwand-Doppelhaken mit Lasche für Kreuzbehang und Etikettenträger verzinkt

Double hook with suspension plate for cross mesh with top label holder zinc  
 Gancho doble con placa colgante para malla metálica cruzada con tope etiqueta zincado  
 Crochet double pour fond grillagé avec bras porte-prix zingué

						
		mm	mm	mm		kg
2510431510		4,8	50	150	50	11,8
2510432110		4,8	50	200	50	15,8
2510432510		4,8	50	250	50	19,7
2510433110		4,8	50	300	50	23,7

Artikel nur auf Anfrage erhältlich / only on request / uniquement sur demande / solamente a pedido  
 Die passenden Pendeltaschen finden Sie auf der Seite 35.



# HOHAGE

Wir biegen Lösungen

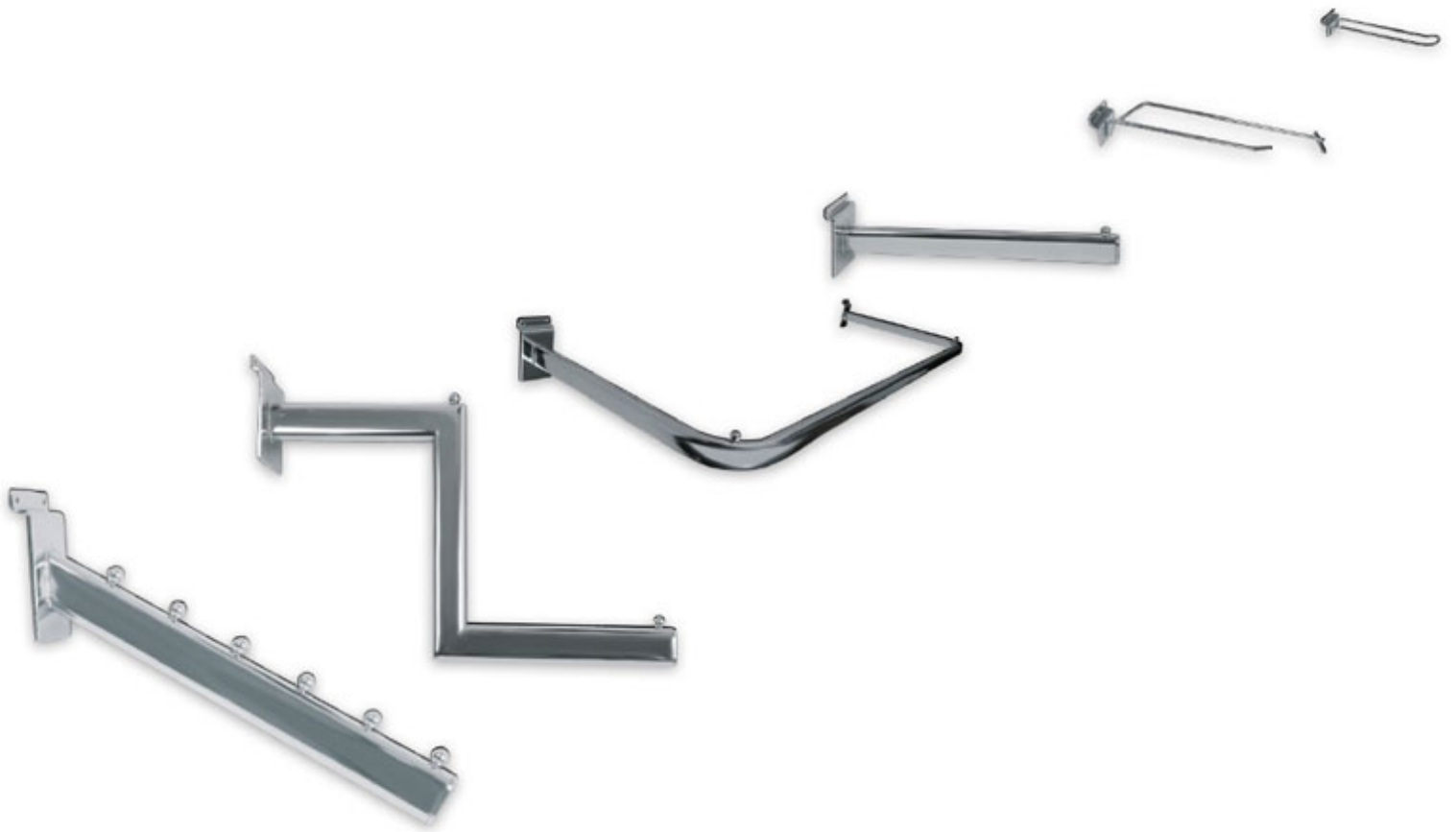

# 7

## Lamellenwandhaken

Slatwall hooks

Ganchos para panel de lamas

Crochets pour fond lame





## Lamellenwand-Einfachhaken verzinkt

Single hook for slatwall zinc

Gancho simple para panel de lamas zincado

Crochet simple pour fond lame zingué



				 mm	 mm		 kg
2492941010				4,8	100	50	4,9
2492941510				4,8	150	50	5,6
2492942010				4,8	200	50	6,3
2492942510				4,8	250	50	7,0
2492943010				4,8	300	50	7,7
2492944010				4,8	400	50	8,4





## Lamellenwand-Doppelhaken verzinkt

Double hook for slatwall zinc

Gancho doble para panel de lamas zincado

Crochet double pour fond lame zingué



				 mm	 mm		 kg
2492541010				4,8	100	50	5,7
2492541510				4,8	150	50	6,4
2492542010				4,8	200	50	7,1
2492542510				4,8	250	50	7,8
2492543010				4,8	300	50	8,5
2492544010				4,8	400	50	10,1





## Lamellenwand-Einfachhaken mit Etikettenträger verzinkt

Single hook for slatwall with top label holder zinc

Gancho simple con tope etiqueta para panel de lamas zincado

Crochet simple avec bras porte-prix pour fond lame zingué



				 mm	 mm		 kg
6092421010				4,8	100	50	8,9
6092421510				4,8	150	50	9,6
6092422010				4,8	200	50	10,3
6092422510				4,8	250	50	11,0
6092423010				4,8	300	50	11,7

Die passenden Pendeltaschen finden Sie auf der Seite 35.





## Lamellenwand-Doppelhaken mit Etikettenträger verzinkt

Double hook for slatwall with top label holder zinc

Gancho doble con tope etiqueta para panel de lamas zincado

Crochet double avec bras porte-prix pour fond lame zingué



				 mm	 mm		 kg
6092541010				4,8	100	50	9,7
6092541510				4,8	150	50	10,4
6092542010				4,8	200	50	11,1
6092542510				4,8	250	50	11,8
6092543010				4,8	300	50	12,5





Die passenden Pendeltaschen finden Sie auf der Seite 35.

## Lamellenwand-Abhängearm gerade aus Ovalrohr, mit Begrenzungskugel verchromt

Straight front arm with ball, for slatwall, made of oval bar chrome finish

Brazo recto con top para panel de lamas, barra oval cromado

Bras droit avec bille pour fond lame chromé

							
8033823005			300		30x15	1	34,2
8033824005			400		30x15	1	45,6

Artikel nur auf Anfrage erhältlich / only on request / uniquement sur demande / solamente a pedido







## Lamellenwand-Abhängearm schräg aus Ovalrohr, mit Stiften verchromt

Sloping front arm, for slatwall, made of oval bar chrome finish

Brazo inclinado para panel de lamas, barra oval cromado

Bras incliné pour fond lame chromé

							
8033772305*			230		30x15	1	30,5
8033773805**			380		30x15	1	50,4

\* mit 6 Stiften / pins /  
\*\*mit 10 Stiften / pins /  
Artikel nur auf Anfrage erhältlich / only on request / uniquement sur demande / solamente a pedido







## Lamellenwand-Abhängearm schräg aus Ovalrohr, mit Haken verchromt

Sloping front arm with hooks, for slatwall, made of oval bar chrome finish

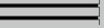
Brazo inclinado con ganchos para panel de lamas, barra oval cromado

Bras incliné avec crochets pour fond lame chromé

							
8033782005*			200		30x15	1	40,0
8033783005**			300		30x15	1	60,0

\* mit 3 Haken / hooks / ganchos / crochets  
\*\*mit 5 Haken / hooks / ganchos / crochets  
Artikel nur auf Anfrage erhältlich / only on request / uniquement sur demande / solamente a pedido









## Lamellenwand-Stufenabhängearm aus Ovalrohr, mit Kugeln verchromt

Stepped front arm with balls, for slatwall, made of oval bar chrome finish

Brazo escalera con botones para panel de lamas, barra oval cromado

Bras à niveaux avec billes pour fond lame chromé

							
8033793505			350	200	30x15	1	55,3

Artikel nur auf Anfrage erhältlich / only on request / uniquement sur demande / solamente a pedido









## Lamellenwand-Ballhalter verchromt

**Ball holder for slatwall** chrome finish  
**Soporte balón para panel de lamas** cromado  
**Support pour ballons** chromé







							
8057821605				6,0	150	1	21,5

Artikel nur auf Anfrage erhältlich / only on request / uniquement sur demande / solamente a pedido

## Lamellenwand-Einfachhaken verchromt

**Single hook for slatwall** chrome finish  
**Gancho simple para panel de lamas** cromado  
**Crochet simple pour fond lame** chromé







							
8092940805				5,0	80	50	4,6
8092941505				5,0	150	50	5,6
8092942505				5,0	250	50	7,0

## Lamellenwand-Doppelhaken verchromt

**Double hook for slatwall** chrome finish  
**Gancho doble para panel de lamas** cromado  
**Crochet double pour fond lame** chromé







							
8092541505				3,4	150	50	6,4
8092542005				5,0	200	50	7,1
8092542505				5,0	250	50	7,8

## Lamellenwand-Doppelhaken mit Etikettenträger verchromt

**Double hook for slatwall with top label holder** chrome finish  
**Gancho doble con tope etiqueta para panel de lamas** cromado  
**Crochet double avec bras porte-prix pour fond lame** chromé



							
8192542005				5,0	200	50	11,1
8192542505				5,0	250	50	11,8
8192543005				5,0	300	50	12,5

Die passenden Pendeltaschen finden Sie auf der Seite 35.



# HOHAGE

Wir biegen Lösungen

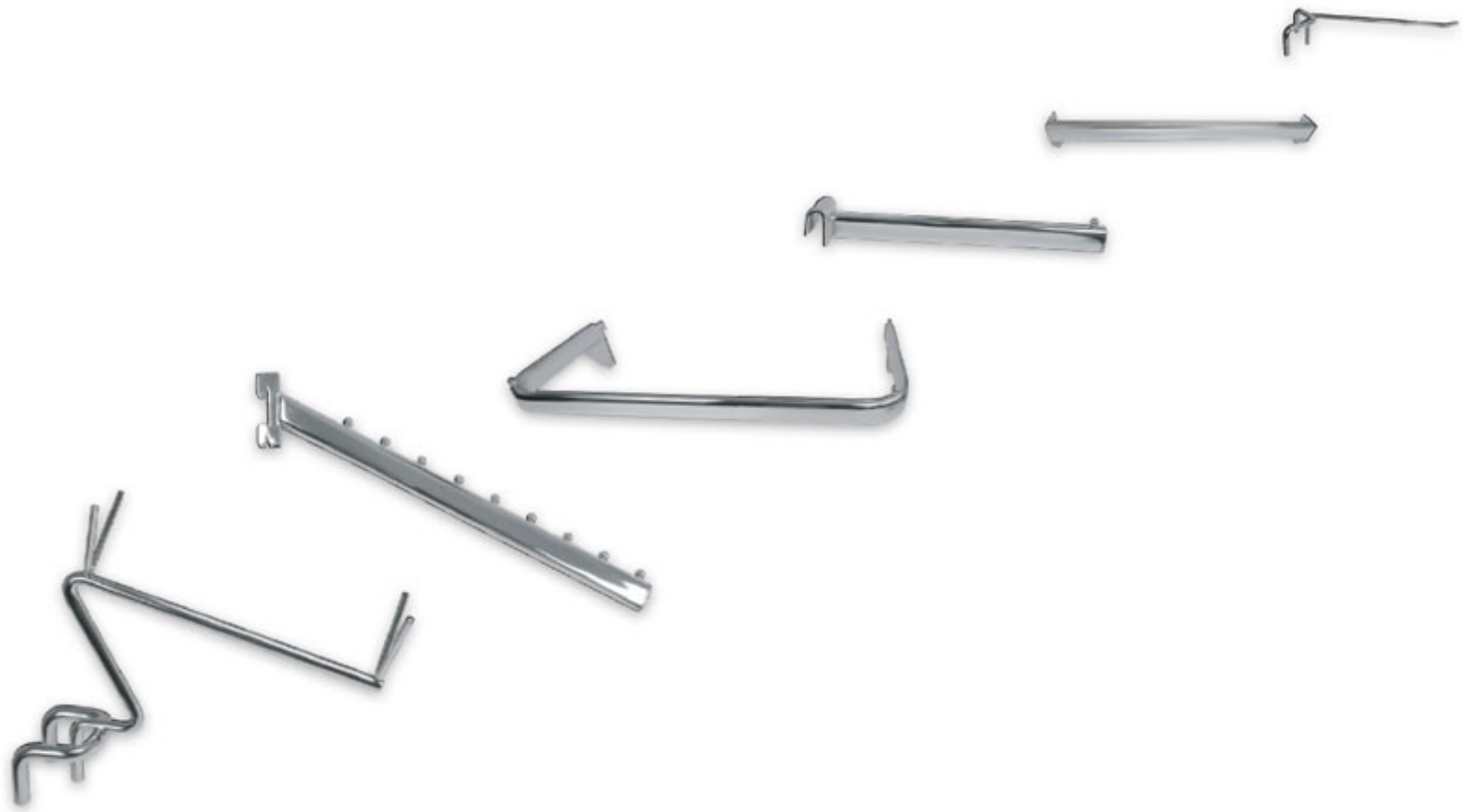

## Chromprogramm

Chromium-plated products  
Productos cromados  
Produits chromés

## Konfektionsrahmen aus Flachovalrohr Tiefe 250 mm und 350 mm

Side hanging frame for clothing, made of flat oval tube depth 250 and 350 mm

Barra expositora para ropa, tubo oval plano profundidad 250 y 350 mm

Cadre de confection, en tube ovale profondeur 250 et 350 mm



			mm	mm	mm		kg
8051100625			625	250	30x15	1	105,8
8051101000			1000	250	30x15	1	169,3
8051101250			1250	250	30x15	1	211,6
8061100625			625	350	30x15	1	105,8
8061101000			1000	350	30x15	1	169,3
8061101250			1250	350	30x15	1	211,6

Artikel nur auf Anfrage erhältlich / only on request / uniquement sur demande / solamente a pedido

## Trageschiene aus Flachovalrohr 30 x 15 mm

Support bar made of flat oval tube 30 x 15 mm

Barra de carga, tubo oval plano 30 x 15 mm

Barre de charge en tube ovale 30 x 15 mm



			mm	mm	mm		kg
8051000625			625		30x15	1	81,0
8051001000			1000		30x15	1	129,0
8051001250			1250		30x15	1	161,0

Artikel nur auf Anfrage erhältlich / only on request / uniquement sur demande / solamente a pedido

## Einfachhaken für Trageschiene 30 x 15 mm

Holder for support bar 30 x 15 mm

Soporte para barra de carga 30 x 15 mm

Crochet simple pour barre de charge 30 x 15 mm



			mm	mm			kg
8051201505	15		5,0	150		1	5,9
8051202005	15		5,0	250		1	9,9
8051211505	15		7,0	150		1	8,3
8051212505	15		7,0	250		1	13,8
8051223005	15		9,0	300		1	17,6
8051224005	15		9,0	400		1	19,9

Artikel nur auf Anfrage erhältlich / only on request / uniquement sur demande / solamente a pedido

## Abhängearm gerade für Trageschiene 30 x 15 mm

Straight display arm for support bar 30 x 15 mm

Brazo recto para barra de carga 30 x 15 mm

Bras droit pour barre de charge 30 x 15 mm



			mm	mm	mm		kg
8051253005	15			300	30x15	1	36,5
8051254005	15			400	30x15	1	48,7

Artikel nur auf Anfrage erhältlich / only on request / uniquement sur demande / solamente a pedido

## Abhängearm schräg, 30° geneigt mit Kugeln für Trageschiene 30 x 15 mm

Sloping front arm, 30° inclined, with balls, for support bar 30 x 15 mm  
 Brazo inclinado 30°, con botones, para barra de carga 30 x 15 mm  
 Bras incline 30°, avec billes, pour barre de charge 30 x 15 mm







							
8051244005	15		400		30x15	1	47,1



Artikel nur auf Anfrage erhältlich / only on request / uniquement sur demande / solamente a pedido

## Stufenabhängearm für Trageschiene 30 x 15 mm

Stepped arm for support bar 30 x 15 mm  
 Brazo escalera para barra de carga 30 x 15 mm  
 Bras à niveaux, pour barre de charge 30 x 15 mm







							
8051263505	15		350	200	30x15	1	58,5



Artikel nur auf Anfrage erhältlich / only on request / uniquement sur demande / solamente a pedido

## Frontalabhängearm für Trageschiene 30 x 15 mm

Front arm for support bar 30 x 15 mm  
 Brazo recto para barra de carga 30 x 15 mm  
 Bras pour barre de charge 30 x 15 mm

							
8051304005	15		400	200	30x15	1	58,5



Artikel nur auf Anfrage erhältlich / only on request / uniquement sur demande / solamente a pedido

## Präsenter für Ski-, Snowboard- und Bergschuhe für Trageschiene 30 x 15 mm

Holder for ski, snowboard and climbing boots, for support bar 30 x 15 mm  
 Soporte para ski, botas de snowboard y escalada, para barra de carga 30 x 15 mm  
 Support pour chaussures à ski/ snowboard, pour barre de charge 30 x 15 mm

						
3041620105	15	5,0	200		20	32,7



Mindestbestellmenge 500 Stück / minimum order quantity 500 pieces  
 Quantité minimale de commande: 500 pièces / cantidad mínima por pedido: 500 unidades

## Handschuhbügel teleskopierbar für Trageschiene 30 x 15 mm

Telescopic holder for the presentation of gloves, for support bar 30 x 15 mm

Soporte telescópico para guantes, para barra de carga 30 x 15 mm

Présentoir télescopique de gants, pour barre de charge 30 x 15 mm



Article-Nr.	Trageschiene	Ø	Abstand	Abstand	Abstand	Abstand	Abstand	Abstand	
8051313005	15	6,0/13,0	300-550					1	32,0

Artikel nur auf Anfrage erhältlich / only on request / uniquement sur demande / solamente a pedido

## Hut- und Mützenhalter mit 50 mm Schaumstoff für Trageschiene 30 x 15 mm

Holder for hats and caps with 50 mm foamed material, for support bar 30 x 15 mm

Soporte sombreros y gorras. 50 mm de espuma, para barra de carga 30 x 15 mm

Présentoir de chapeau et bonnet, avec 50 mm mousse, pour barre de charge 30 x 15 mm



Article-Nr.	Trageschiene	Ø	Abstand	Abstand	Abstand	Abstand	Abstand	Abstand	
8051342005	15	7,0	200		200			1	31,0

Artikel nur auf Anfrage erhältlich / only on request / uniquement sur demande / solamente a pedido

## Helmhalter für Trageschiene 30 x 15 mm

Helmet holder for support bar 30 x 15 mm

Soporte de cascos para barra de carga 30 x 15 mm

Présentoir de casque, pour barre de charge 30 x 15 mm





Article-Nr.	Trageschiene	Ø	Abstand	Abstand	Abstand	Abstand	Abstand	Abstand	
8051462505	15	8,0	360		250			1	40,0

Artikel nur auf Anfrage erhältlich / only on request / uniquement sur demande / solamente a pedido

## Trageschiene aus Vierkantrrohr 40 x 20 mm

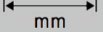
Support bar made of square tube 40 x 20 mm  
Barra de carga, tubo cuadrado 40 x 20 mm  
Barre de charge en tube carré 40 x 20 mm





						
	20		mm		1	kg
8052000625	20		625		1	105,0
8052001005	20		1000		1	145,0
8052001205	20		1250		1	181,0



Artikel nur auf Anfrage erhältlich / only on request / uniquement sur demande / solamente a pedido

## Einfachhaken für Trageschiene 40 x 20 mm

Holder for support bar 40 x 20 mm  
Soporte para barra de carga 40 x 20 mm  
Crochet simple pour barre de charge 40 x 20 mm







						
	20	mm	mm		1	kg
8052061005	20	8,0	100		1	7,3
8052062005	20	8,0	200		1	14,5
8052063005	20	8,0	300		1	21,8
8052064005	20	8,0	400		1	29,1



Artikel nur auf Anfrage erhältlich / only on request / uniquement sur demande / solamente a pedido

## Stufenabhängearm für Trageschiene 40 x 20 mm

Stepped arm for support bar 40 x 20 mm  
Brazo escalera para barra de carga 40 x 20 mm  
Bras à niveaux pour barre de charge 40 x 20 mm







							
	20		mm	mm	mm	1	kg
8052034505	20		450	250	30x15	1	84,8



Artikel nur auf Anfrage erhältlich / only on request / uniquement sur demande / solamente a pedido

## Frontalabhängearm für Trageschiene 40 x 20 mm

Front arm for support bar 40 x 20 mm  
Brazo recto para barra de carga 40 x 20 mm  
Bras pour barre de charge 40 x 20 mm

							
	20		mm	mm	mm	1	kg
8052044505	20		450	250	30x15	1	53,9



Artikel nur auf Anfrage erhältlich / only on request / uniquement sur demande / solamente a pedido







## Trennbügel für Trageschiene 40 x 20 mm

Separator for support bar 40 x 20 mm

Separador para barra de carga 40 x 20 mm

Séparateur pour barre de charge 40 x 20 mm





							
	mm			mm	mm		kg
8052054505	20			8,0	450	1	46,2

Artikel nur auf Anfrage erhältlich / only on request / uniquement sur demande / solamente a pedido

## Trageschiene aus Flachovalrohr 50 x 20 mm

Flat oval support bar 50 x 20 mm  
Barra de carga, tubo oval plano 50 x 20 mm  
Barre de charge en tube ovale 50 x 20 mm





			 mm			 kg
8050031005	20		1000		1	149,0
8050031205	20		1250		1	185,0

Artikel nur auf Anfrage erhältlich / only on request / uniquement sur demande / solamente a pedido



## Abhängeträger 30° geneigt mit 6 Haken für Trageschiene 20 mm

Sloping holder 30° inclined, with 6 hooks, for support bar 20 mm  
Soporte inclinado 30°, con 6 ganchos, para barra de carga 20 mm  
Bras incliné 30°, avec 6 crochets, pour barre de charge 20 mm





			 mm	 mm		 kg
8070294705	20		8,0	470	1	66,0

Artikel nur auf Anfrage erhältlich / only on request / uniquement sur demande / solamente a pedido



## Frontalwareträger 30° geneigt mit 10 Kugeln für Trageschiene 20 mm

Sloping holder 30° inclined, with 10 balls for support bar 20 mm  
Soporte inclinado 30°, con 10 botones, para barra de carga 20 mm  
Bras incliné 30°, avec 10 billes, pour barre de charge 20 mm





			 mm	 mm		 kg
8069334005	20		10,0	415	1	51,0

Artikel nur auf Anfrage erhältlich / only on request / uniquement sur demande / solamente a pedido



## Halter für 10 Tennisschläger 30° geneigt, Unterteiler ummantelt für Trageschiene 20 mm

Holder for 10 tennis rackets, 30° inclined, pins coated for support bar 20 mm  
Soporte para 10 raquetas de tenis, inclinado 30°, con clavijas para barra de 20 mm  
Support incliné 30° pour 10 raquettes de tennis, broches enrobées pour barre de charge 20 mm

			 mm	 mm		 kg
8065644305	20		10,0	430	1	102,0

Artikel nur auf Anfrage erhältlich / only on request / uniquement sur demande / solamente a pedido







## Bügeleisenhalter für Trageschiene 20 mm

Iron holder for support bar 20 mm

Soporte de hierro para barra de carga de 20 mm

Présentoir de fer à repasser, pour barre de charge 20 mm



8020000105	 20		 8,0	 210	 1	 28,7
------------	--	--	---	---	---	--

Artikel nur auf Anfrage erhältlich / only on request / uniquement sur demande / solamente a pedido





## Haartrockenhalter für Trageschiene 20 mm

Hair-dryer holder for support bar 20 mm

Soporte secador para barra de carga 20 mm

Présentoir de sèche-cheveux, pour barre de charge 20 mm



8030000105	 20		 8,0	 100	 1	 30,6
------------	--	--	---	---	---	--

Artikel nur auf Anfrage erhältlich / only on request / uniquement sur demande / solamente a pedido





## Lockenstabhalter für Trageschiene 20 mm

Holder for curling tongs, for support bar 20 mm

Soporte tenacillas, para barra de carga de 20 mm

Présentoir de fer à friser, pour barre de charge 20 mm



8040000105	 20	 8,0	 200		 1	 29,7
------------	--	---	---	--	---	--

Artikel nur auf Anfrage erhältlich / only on request / uniquement sur demande / solamente a pedido



## Wäschetasche rechts/links für Trageschiene 20 mm

Holder for clothes bags, right/left, for support bar 20 mm

Soporte bolsas de tela, a la derecha/izquierda, para barra de carga de 20 mm

Support pour sacs à linge, à droite/gauche, pour barre de charge 20 mm



8077484505	 20	 350	 450		 1	 190,0
8077494505	 20	 350	 450		 1	 190,0

Artikel nur auf Anfrage erhältlich / only on request / uniquement sur demande / solamente a pedido

## Abhängearm schräg, 30° geneigt mit Kugel für Säule 2reihig

Sloping front arm, 30° inclined, with balls, for two-rowed column  
 Brazo inclinado 30°, con botones, para columna doble ranura  
 Bras incliné 30°, avec billes, pour colonne à deux rangées







							
8051274005			400		30x15	1	47,1



Artikel nur auf Anfrage erhältlich / only on request / uniquement sur demande / solamente a pedido

## Schrägabhängearm für Säule 2reihig

Sloping front arm for two-rowed column  
 Brazo inclinado para columna doble ranura  
 Bras incliné pour colonne à deux rangées

							
8052084505			450	300	30x15	1	80,0



Artikel nur auf Anfrage erhältlich / only on request / uniquement sur demande / solamente a pedido

# HOHAGE

Wir biegen Lösungen

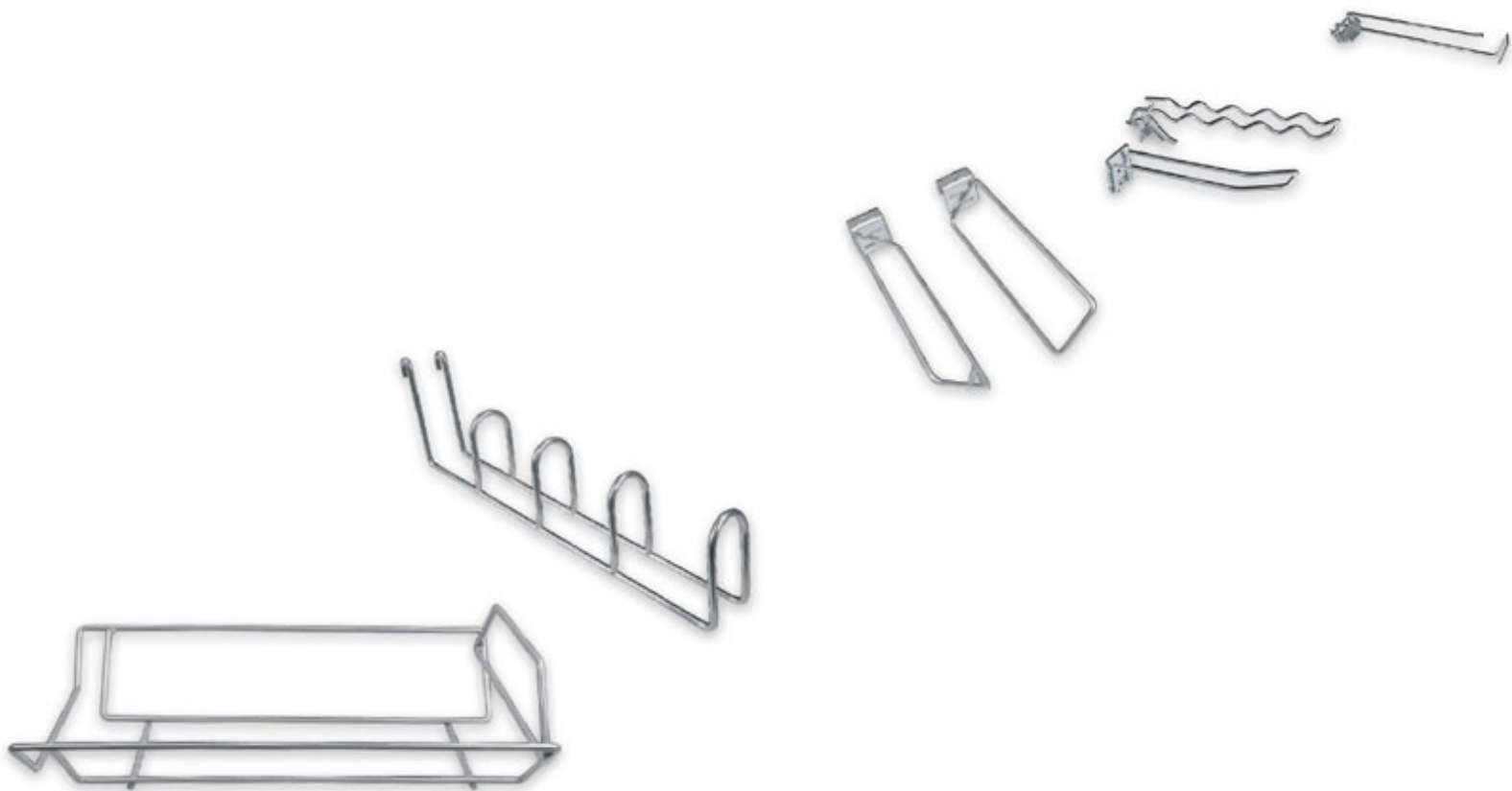

## **Specials**

**Special means of presentation**

**Presentaciones especiales**

**Produits spéciaux de présentation**

## Kleinteilerondell mit 8 Doppelhaken RAL 9006

Rondel for consumables with 8 double hooks RAL 9006

Exhibidor con 8 ganchos dobles RAL 9006

Présentoir avec 8 crochets doubles RAL 9006

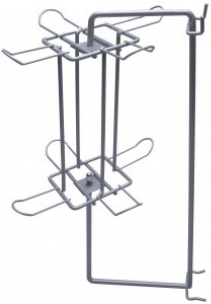

15:	mm (mm)	mm	mm	mm	mm	mm	kg
125035639006P1	30(3,4)			350	200	1	36,5

Artikel nur auf Anfrage erhältlich / only on request / uniquement sur demande / solamente a pedido

## Backformhalter, seitlich verstellbar RAL 9007

Holder for baking dishes, laterally adjustable RAL 9007

Soporte molde de horno, ajustable lateral RAL 9007

Support pour moules à pâtisserie, ajustable latéralement RAL 9007



	mm	mm	mm	mm	mm	mm	kg
1250369007	20	200-520	150	500	6	180,0	

Artikel nur auf Anfrage erhältlich / only on request / uniquement sur demande / solamente a pedido

## Weinflaschenhalter RAL 9006

Holder for wine bottles RAL 9006

Soporte botella de vino RAL 9006

Porte-bouteille à vin RAL 9006



	mm	mm	mm	mm	mm	mm	kg
3040990124	8,0	185	90	20	22,0		

Mindestbestellmenge 1000 Stück / minimum order quantity 1000 pieces  
Quantité minimale de commande: 1000 pièces / cantidad mínima por pedido: 1000 unidades

## Thekendisplay zur Aufnahme von Hakenleisten RAL 9006

Counter top for racks with hooks RAL 9006

Expositor mostrador RAL 9006

Rangeur comptoir RAL 9006



	mm	mm	mm	mm	mm	mm	kg
3050170124	300	380	140	1	65,0		







Artikel nur auf Anfrage erhältlich / only on request / uniquement sur demande / solamente a pedido

## Einfachhakenleisten für Thekendisplay RAL 9006

Single hook rail for 2 and 3 Level-Display and Counter Top Display RAL 9006

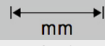
Gancho simple para 2 y 3 niveles exposición y tope superior RAL 9006

Rail de crochets simples pour rangeur comptoir 2 et 3 niveaux et présentoir de comptoir RAL 9006

							
		mm	mm	mm	mm		kg
3050120124	6	4,0	310	60	140	1	27,0
3050110124	7	4,0	310	60	140	1	35,0
3050100124	10	4,0	310	60	140	1	50,0
3050140124	21	4,0	505	60	140	1	105,0









Artikel nur auf Anfrage erhältlich / only on request / uniquement sur demande / solamente a pedido

## Doppelhakenleisten für Thekendisplay RAL 9006

Double hook rail for 2 and 3 Level-Display and Counter Top Display RAL 9006

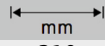
Gancho doble para 2 y 3 niveles exposición y tope superior RAL 9006

Rail de crochets doubles pour rangeur comptoir 2 et 3 niveaux et présentoir de comptoir RAL 9006

							
		mm	mm	mm	mm		kg
3050180124	3	4,0	310	60	140	1	27,0
3050090124	4	4,0	310	60	140	1	36,0
3050130124	6	4,0	310	60	140	1	54,0







Artikel nur auf Anfrage erhältlich / only on request / uniquement sur demande / solamente a pedido

## Tischdisplays RAL 9006

Table displays RAL 9006

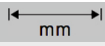
Expositor de mesa RAL 9006

Présentoir de comptoir RAL 9006

							
				mm	mm		kg
4028527524A				290	295	1	118,2
4033607024A				335	490	1	201,0

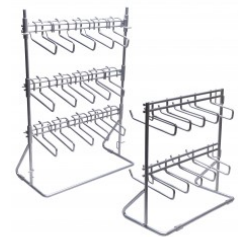





Artikel nur auf Anfrage erhältlich / only on request / uniquement sur demande / solamente a pedido

## Sägenhalter für 6 Sägen RAL 9006

Display saw holder suitable for 6 saws RAL 9006

Soporte expositor, preparado para 6 sierras RAL 9006

Porte-scie pour 6 scies RAL 9006

							
					mm		kg
6009006205					205	1	41,8
6009006300					300	1	45,7

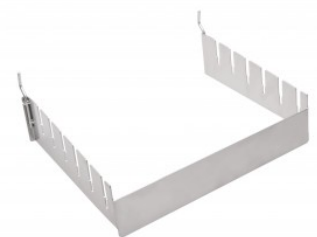







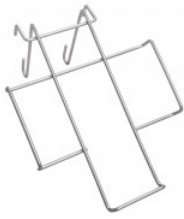

Artikel nur auf Anfrage erhältlich / only on request / uniquement sur demande / solamente a pedido



## Halter für Fahrradhelme RAL 9007

Holder for bicycle helmets RAL 9007  
 Soporte para casco de bici RAL 9007  
 Support pour casque bicyclette RAL 9007







						
3020070100	100	240	150	300	1	31,0

Artikel nur auf Anfrage erhältlich / only on request / uniquement sur demande / solamente a pedido

## Promotionhaken mit Magnetfuß verzinkt

Promotion hook with magnet base zinc  
 Gancho con pie magnético zincado  
 Crochet promotion avec base aimant zingué







				
3020371510	300	150	25	16,0

Mindestbestellmenge 250 Stück / minimum order quantity 250 pieces  
 Quantité minimale de commande: 250 pièces / cantidad mínima por pedido: 250 unidades

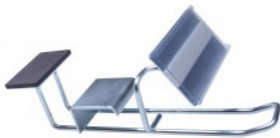
## Promotionhaken für Fachböden verzinkt

Promotion hook for lower shelves zinc  
 Gancho para estantes zincado  
 Crochet promotion pour tablettes zingué





				
3040881710F	4,0	170	50	16,0

Mindestbestellmenge 700 Stück / minimum order quantity 700 pieces  
 Quantité minimale de commande: 700 pièces / cantidad mínima por pedido: 700 unidades

## Doppelblisterleiste für Fachböden RAL 9006

Doubles blister strip for lower shelves RAL 9006  
 Tira blister doble para estantes RAL 9006  
 Double tringle support blister pour tablettes RAL 9006









			
1250180642	330	35	16,0

Artikel nur auf Anfrage erhältlich / only on request / uniquement sur demande / solamente a pedido

## Doppelhaken mit 5 Wellen / Anschraubhaken verzinkt

Corrugated hook with 5 corrugations / Hook to screw on zinc  
 Gancho doble con 5 ondas / Gancho para atornillar zincado  
 Crochet ondulé avec 5 ondes / Crochet à visser zingué







						
	mm	mm	mm	mm	kg	
2442652510	30	4,8	230	50	11,0	
2492581010		4,8	100	50	8,0	
2492582010		4,8	200	50	9,0	
2492582510		4,8	250	50	9,5	
2492583010		4,8	300	50	10,0	



Mindestbestellmenge 500 Stück / minimum order quantity 500 pieces  
 Quantité minimale de commande: 500 pièces / cantidad mínima por pedido: 500 unidades

## Stielhalter seitlich offen mit Schild 60 x 34 mm verzinkt

Handle holder, laterally open, with plate 60 x 34 mm zinc  
 Soporte mango, abierto por el lateral, con placa 60 x 34 mm zincado  
 Support de manche, ouvert latéralement, avec plaque 60 x 34 mm zingué







						
15 / 25	mm	mm	mm	mm	kg	
7504504542-25	75	8,0	400/450	50	50,0	



Artikel nur auf Anfrage erhältlich / only on request / uniquement sur demande / solamente a pedido

## Haken für Präsentation von Brauseköpfen verzinkt

Hook for the presentation of quench head zinc  
 Gancho para presentación de mango de ducha zincado  
 Crochet pour la présentation de tuyau de douche zingué







						
15	mm	mm	mm	mm	kg	
2415403010ET	30	4,8	300	25	22,0	



Artikel nur auf Anfrage erhältlich / only on request / uniquement sur demande / solamente a pedido

## Haken für Einhandzwingen mit Schild 85 x 200 mm leichte Version RAL 9005

Clamping Hook Quick Grip with plate 85 x 200 mm, light model RAL 9005  
 Soporte con abrazadera con placa 85 x 200 mm, modelo ligero RAL 9005  
 Support outil plaque information 85 x 200 mm RAL 9005

						
15 / 25	mm	mm	mm	mm	mm	kg
3050010124	75	8,0	200	230/410	6	81,5



Artikel nur auf Anfrage erhältlich / only on request / uniquement sur demande / solamente a pedido







## Haken für Einhandzwingen mit Schild 85 x 200 mm, mit Bandaufhängung schwere Version RAL 9005

Clamping Hook Quick Grip with plate 85 x 200 mm, heavy model RAL 9005

Soporte con abrazadera con placa 85 x 200 mm, modelo duro RAL 9005

Support outil avec sécurité plaque information 85 x 200 mm RAL 9005



						
3050220124	75	3,5x15	200	230/410	6	83,0

Artikel nur auf Anfrage erhältlich / only on request / uniquement sur demande / solamente a pedido

## Prospektkorb DIN Lang Hochformat, Fülltiefe 35 mm verzinkt

Basket for leaflets DIN long portrait format, depth 35 mm zinc

Portafolletto, formato portrait DIN largo, profundidad 35 mm zincado

Corbeille pour prospectus, format portrait DIN long, profondeur 35 mm zinguée

:15: / :25:					 mm		 kg
9940-113070					4,0	1	10,1

Mindestbestellmenge 100 Stück / minimum order quantity 100 pieces  
Quantité minimale de commande: 100 pièces / cantidad mínima por pedido: 100 unidades





## Prospektkorb DIN A6 Hochformat, Fülltiefe 35 mm verzinkt

Basket for leaflets DIN A6 portrait format, depth 35 mm zinc

Portafolletto, formato portrait DIN A6, profundidad 35 mm zincado

Corbeille pour prospectus, format portrait DIN A6, profondeur 35 mm zinguée

:15: / :25:					 mm		 kg
9946-113070					4,0	1	8,0

Mindestbestellmenge 100 Stück / minimum order quantity 100 pieces  
Quantité minimale de commande: 100 pièces / cantidad mínima por pedido: 100 unidades



## Prospektkorb DIN A5 Hochformat, Fülltiefe 35 mm verzinkt

Basket for leaflets DIN A5 portrait format, depth 35 mm zinc

Portafolletto, formato portrait DIN A5, profundidad 35 mm zincado

Corbeille pour prospectus, format portrait DIN A5, profondeur 35 mm zinguée

:15: / :25:					 mm		 kg
9941-113070					4,0	1	10,6

Mindestbestellmenge 100 Stück / minimum order quantity 100 pieces  
Quantité minimale de commande: 100 pièces / cantidad mínima por pedido: 100 unidades



## Prospektkorb DIN A4 Hochformat, Fülltiefe 35 mm verzinkt

Basket for leaflets DIN A4 portrait format, depth 35 mm zinc

Portafolletto, formato portrait DIN A4, profundidad 35 mm zincado

Corbeille pour prospectus, format portrait DIN A4, profondeur 35 mm zinguée

:15: / :25:					 mm		 kg
9942-113070					4,0	1	14,6

Mindestbestellmenge 100 Stück / minimum order quantity 100 pieces  
Quantité minimale de commande: 100 pièces / cantidad mínima por pedido: 100 unidades

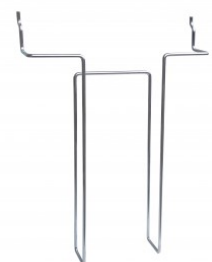



## Aktionsleiste aus Draht mit 19 Haken, Schild 40 x 50 mm RAL 9006 RAL 9006

Merchandising strip of wire with 19 hooks, plate 40 x 50 mm RAL 9006

Tira de alambre, con 19 ganchos, placa 40 x 50 mm RAL 9006

Tringle à promotion en fil, avec 19 crochets, plaque 40 x 50 mm RAL 9006



1250211101					 6,0		 1100
Artikel nur auf Anfrage erhältlich / only on request / uniquement sur demande / solamente a pedido							

## Aktionsleiste aus Draht mit 11 Haken, Schild 40 x 80 mm RAL 7015

Merchandising strip made of wire, with 11 hooks, plate 40 x 80 mm RAL 7015

Tira de alambre, con 11 ganchos, placa 40 x 80 mm RAL 7015

Tringle à promotion, avec 11 crochets, plaque 40 x 80 mm RAL 7015



1250210722						 722	
Artikel nur auf Anfrage erhältlich / only on request / uniquement sur demande / solamente a pedido							



## Aktionsleiste aus Draht mit 10 Haken, Schild 40 x 80 mm RAL 9006

Merchandising strip made of wire, with 10 hooks, plate 40 x 80 mm RAL 9006

Tira de alambre, con 10 ganchos, placa 40 x 80 mm RAL 9006

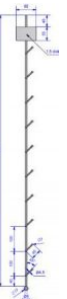
Tringle à promotion en fil, avec 10 crochets, plaque 40 x 80 mm RAL 9006



1250211100					 6,0	 1100	
Artikel nur auf Anfrage erhältlich / only on request / uniquement sur demande / solamente a pedido							



## Aktionsleiste aus Draht mit 18 Haken, Schild 40 x 80 mm RAL 7035

Merchandising strip made of wire with 18 hooks, plate 40 x 80 mm RAL 7035

Tira de alambre, con 18 ganchos, placa 40 x 80 mm RAL 7035

Tringle à promotion en fil, avec 18 crochets, plaque 40 x 80 mm RAL 7035







1250211155					 5,0	 1155	
Artikel nur auf Anfrage erhältlich / only on request / uniquement sur demande / solamente a pedido							

## Aktionsleiste aus Blech mit 13 Haken, Schild 75 x 40 mm RAL 7035

Merchandising strip made of metal, with 13 hooks, plate 75 x 40 mm RAL 7035

Tira metal, con 13 ganchos, placa 75 x 40 mm RAL 7035

Tringle à promotion en métal, avec 13 crochets, plaque 75 x 40 mm RAL 7035

				 mm	 mm		 kg
1250211150				2,0	1150	50	36,5









Artikel nur auf Anfrage erhältlich / only on request / uniquement sur demande / solamente a pedido

## Fächerhaken 2 verzinkt

Wire hook with 2 compartments zinc

Gancho de alambre, con 2 compartimentos zincado

Crochet en fil avec 2 compartiments zingué

				 mm	 mm	 mm		 kg
2502410110				5,0	90	150	250	14,0









Artikel nur auf Anfrage erhältlich / only on request / uniquement sur demande / solamente a pedido

## Fächerhaken 4 verzinkt

Wire hook with 4 compartments zinc

Gancho de alambre, con 4 compartimentos zincado

Crochet en fil avec 4 compartiments zingué

				 mm	 mm	 mm		 kg
2502420110				5,0	90	315	130	24,0







Artikel nur auf Anfrage erhältlich / only on request / uniquement sur demande / solamente a pedido

## Brettchenhalterung mit transparentem Gummischlauch verzinkt

Universal slat holder with transparent rubber coating zinc

Soporte universal con goma transparente zincado

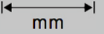
Porte-planchette avec enrobage en caoutchouc transparent zingué

				 mm	 mm		 kg
3050503010LI	20			7,0	300	50	28,0
3050503010RE	20			7,0	300	50	26,5







Artikel nur auf Anfrage erhältlich / only on request / uniquement sur demande / solamente a pedido

## Edelstahl-Doppelhaken für Trageschiene 15 mm

Double hook made of stainless, suitable for rear support bar 15 mm  
 Gancho dobl, acero inoxidable, para barra de carga de 15 mm  
 Crochet double emboîtable pour barre de 15 mm, en acier inoxydable







				 mm	 mm		 kg
2492152501	15			4,8	250	50	13,0
2492153501	15			4,8	350	50	16,5

Artikel nur auf Anfrage erhältlich / only on request / uniquement sur demande / solamente a pedido

## Edelstahl-Doppelhaken mit Etikettenträger für Trageschiene 15 mm

Double hook with label holder made of stainless steel, suitable for rear support bar 15 mm  
 Gancho doble con tope etiqueta, acero inoxidable, para barra de carga de 15 mm  
 Crochet double emboîtable avec bras porte-prix pour barre de 15 mm, en acier inoxydable







				 mm	 mm		 kg
6092152501	15			4,8	250	50	19,0
6092153501	15			4,8	350	50	22,5

Artikel nur auf Anfrage erhältlich / only on request / uniquement sur demande / solamente a pedido

## Edelstahl-Doppelhaken für Trageschiene 20 mm

Double hook made of stainless, suitable for rear support bar 20 mm  
 Gancho doble, acero inoxidable, para barra de carga de 20 mm  
 Crochet double emboîtable pour barre de 20 mm, en acier inoxydable







				 mm	 mm		 kg
2494752501	20			4,8	250	50	18,0
2494753501	20			4,8	350	50	22,0

Artikel nur auf Anfrage erhältlich / only on request / uniquement sur demande / solamente a pedido

## Edelstahl-Doppelhaken mit Etikettenträger für Trageschiene 20 mm

Double hook with label holder made of stainless steel, suitable for rear support bar 20 mm  
 Gancho doble con tope etiqueta, acero inoxidable, para barra de carga de 20 mm  
 Crochet double emboîtable avec bras porte-prix pour barre de 20 mm, en acier inoxydable







				 mm	 mm		 kg
6094752501	20			4,8	250	50	23,0
6094753501	20			4,8	350	50	27,0

Artikel nur auf Anfrage erhältlich / only on request / uniquement sur demande / solamente a pedido

## Edelstahl-Schwerlasthaken für Trageschiene 15 mm

Triple hook heavy type made of stainless steel, suitable for rear support bar 15 mm  
 Gancho triple de acero inoxidable, para barra de carga de 15 mm  
 Support lourd emboîtable pour barre de 15 mm, en acier inoxydable





				 mm	 mm		 kg
2492163001	15			5,0/5,0	300	50	26,0
2492164001	15			5,0/5,0	400	50	30,0



Artikel nur auf Anfrage erhältlich / only on request / uniquement sur demande / solamente a pedido

## Edelstahl-Schwerlasthaken mit Etikettenträger für Trageschiene 15 mm

Triple hook heavy type with label holder made of stainless steel, suitable for rear support bar 15 mm  
 Gancho triple con tope etiqueta, de acero inoxidable, para barra de carga de 15 mm  
 Support lourd emboîtable avec bras porte-prix pour barre de 15 mm, en acier inoxydable





				 mm	 mm		 kg
6092163001	15			5,0/5,0	300	50	30,0
6092164001	15			5,0/5,0	400	50	34,0



Artikel nur auf Anfrage erhältlich / only on request / uniquement sur demande / solamente a pedido

## Edelstahl-Schwerlasthaken für Trageschiene 20 mm

Triple hook heavy type made of stainless steel, suitable for rear support bar 20 mm  
 Gancho triple de acero inoxidable, para barra de carga de 20 mm  
 Support lourd emboîtable pour barre de 20 mm, en acier inoxydable





				 mm	 mm		 kg
2492753005	20			5,0/5,0	300	50	26,0
2492754005	20			5,0/5,0	400	50	30,0



Artikel nur auf Anfrage erhältlich / only on request / uniquement sur demande / solamente a pedido

## Edelstahl-Schwerlasthaken mit Etikettenträger für Trageschiene 20 mm

Triple hook heavy type with label holder made of stainless steel, suitable for rear support bar 20 mm  
 Gancho triple con tope etiqueta, de acero inoxidable, para barra de carga de 20 mm  
 Support lourd emboîtable avec bras porte-prix pour barre de 20 mm, en acier inoxydable

				 mm	 mm		 kg
6092753005	20			5,0/5,0	300	50	30,0
6092754005	20			5,0/5,0	400	50	34,0



Artikel nur auf Anfrage erhältlich / only on request / uniquement sur demande / solamente a pedido



# HOHAGE

Wir biegen Lösungen

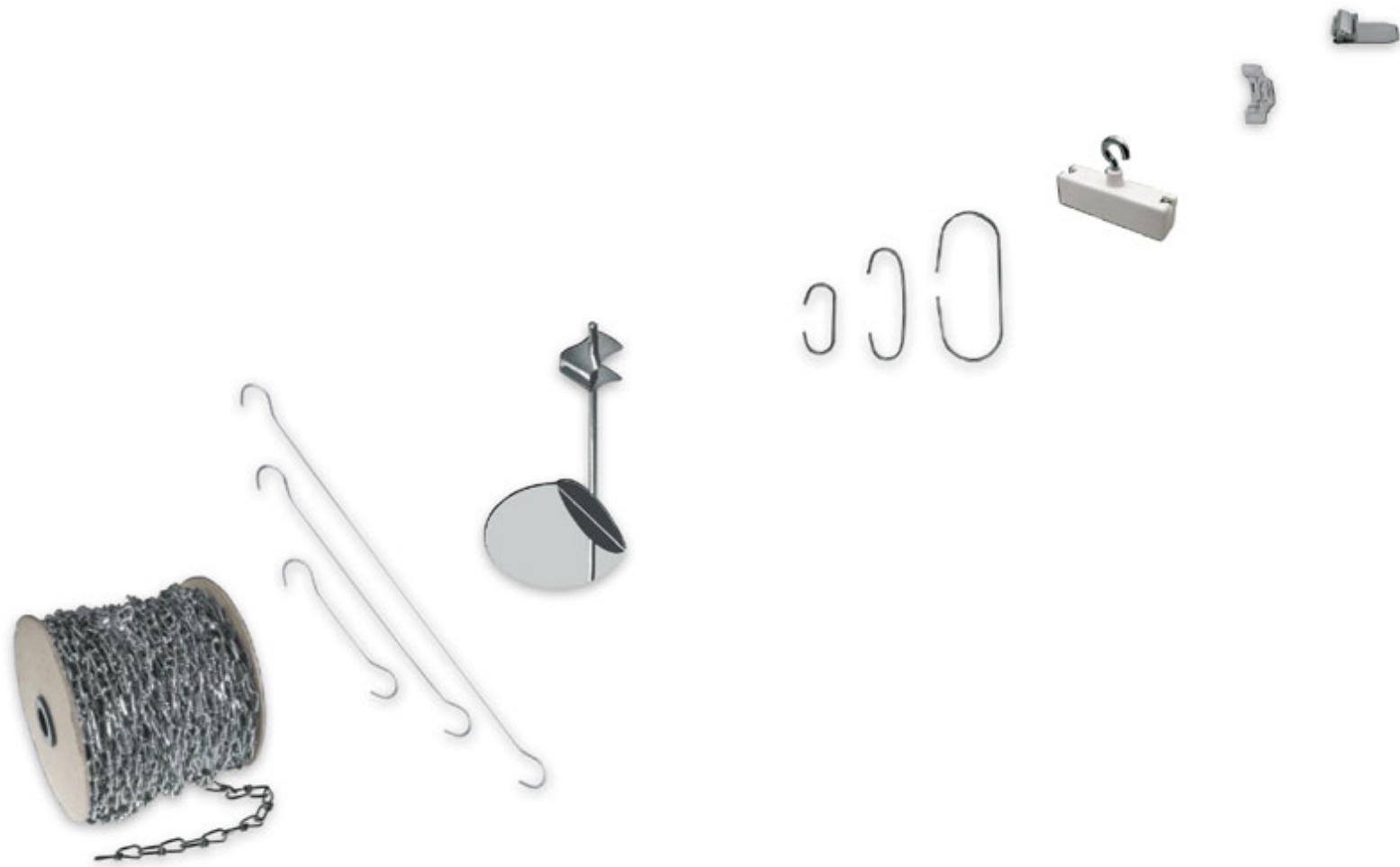

10

**Abhänge- und  
Auszeichnungssysteme**

Means of sale and decoration  
Productos de decoración Produits de  
décoration

## Abhängehaken verzinkt

Universal suspension hook zinc

Gancho suspensión universal zincado

Crochet de suspension universel zingué



	⌀ mm	l mm			📦	📦 kg
0080-0200060	2,0	60			50	0,3
0080-0200100	2,0	100			50	0,4
0080-0200150	2,0	150			50	0,5
0080-0200200	2,0	200			50	0,6
0080-0200250	2,0	250			50	0,8
0080-0200300	2,0	300			50	0,9
0080-0200350	2,0	350			50	1,0
0080-0200400	2,0	400			50	1,1
0080-0200450	2,0	450			50	1,3
0080-0200500	2,0	500			50	1,4
0080-0200600	2,0	600			50	1,6
0080-0200700	2,0	700			50	1,9
0080-0200750	2,0	750			50	2,0
0080-0200800	2,0	800			50	2,1
0080-0200900	2,0	900			50	2,4
0080-0201000	2,0	1000			50	2,6
0080-0201250	2,0	1250			50	3,0
0080-0201300	2,0	1300			50	3,4
0080-0201500	2,0	1500			50	3,9
0080-0201800	2,0	1800			50	4,5
0080-0202000	2,0	2000			50	5,2

## Paneeldeckenhaken für 10 mm Profil verzinkt

Panel ceiling hook for 10 mm profile zinc  
 Gancho para panel, para perfil 10 mm zincado  
 Crochet à plafond lambris pour profil 10 mm zingué

	Ø mm	l mm			50	kg
0062-0200060	2,0	60			50	0,3
0062-0200150	2,0	150			50	0,5
0062-0200300	2,0	300			50	0,9
0062-0200500	2,0	500			50	1,4
0062-0200700	2,0	700			50	1,9
0062-0201000	2,0	1000			50	2,6



## Paneeldeckenhaken für 20 mm Profil verzinkt

Panel ceiling hook for 20 mm profile zinc  
 Gancho para panel para perfil 20 mm zincado  
 Crochet à plafond lambris pour profil 20 mm zingué

	Ø mm	l mm			50	kg
0053-0200060	2,0	60			50	0,3
0053-0200150	2,0	150			50	0,5
0053-0200300	2,0	300			50	0,9
0053-0200500	2,0	500			50	1,4
0053-0200700	2,0	700			50	1,9
0053-0201000	2,0	1000			50	2,6



## Gitterdeckenhaken verzinkt

Grid ceiling hook zinc  
 Gancho para rejilla zincado  
 Crochet à plafond grillagé zingué

	Ø mm	l mm			50	kg
0068-0200060	2,0	60			50	0,3
0068-0200150	2,0	150			50	0,5
0068-0200300	2,0	300			50	0,9
0068-0200500	2,0	500			50	1,4
0068-0200700	2,0	700			50	1,9
0068-0201000	2,0	1000			50	2,8



## Gitterdeckenhaken verzinkt

Grid ceiling hook zinc  
 Gancho para rejilla zincado  
 Crochet à plafond grillagé zingué

	Ø mm	l mm			50	kg
0063-0200060	2,0	60			50	0,3
0063-0200150	2,0	150			50	0,5
0063-0200300	2,0	300			50	0,9
0063-0200500	2,0	500			50	1,4
0063-0200700	2,0	700			50	1,9
0063-0201000	2,0	1000			50	2,8



## Spiralabhangung

Spiral suspension hook  
Gancho espiral para colgar  
Crochet de suspension  spirale



	∅ mm	l mm	F <sub>N</sub>			
0085-0101400	1,0	1400	0,4		100	0,1
0085-0101600	1,0	1600	1,0		50	0,1
0085-0103000	1,0	3000	1,0		25	0,5

## Abhangehaken unsichtbar, aus Edelstahl

Universal suspension hook invisible, made of stainless steel  
Gancho suspensi3n universal invisible, de acero inoxidable  
Crochet de suspensi3n universel invisible, en acier inoxydable



	∅ mm	l mm				
0400-0080150	0,8	150			50	0,1
0400-0080250	0,8	250			50	0,2
0400-0080500	0,8	500			50	0,3
0400-0080750	0,8	750			50	0,4
0400-0081000	0,8	1000			50	0,5

## Lochdeckenhooken verzinkt

Ceiling hook zinc  
Gancho para techo zincado  
Crochet  plafond zingu



	∅ mm	l mm				
0073-0200060	2,0	60			50	0,3
0073-0200150	2,0	150			50	0,5
0073-0200300	2,0	300			50	0,8
0073-0200500	2,0	500			50	1,3
0073-0200700	2,0	700			50	2,0
0073-0201000	2,0	1000			50	2,6

## Paneeldeckenhooken fur Profil 20 mm verzinkt

Panel ceiling hook for profile 20 mm zinc  
Gancho para panel para perfil 20 mm zincado  
Crochet  plafond lambris pour profil 20 mm zingu





	∅ mm	l mm				
2502070543	2,0	85			50	0,4

Wir biegen Lösungen

## Paneeldeckenhaken für Profil 20 mm verzinkt



Panel ceiling hook for profile 20 mm zinc  
Gancho para panel para perfil 20 mm zincado  
Crochet à plafond lambris pour profil 20 mm zingué

		 mm	 mm			 kg	
1200510510		2,0	60			50	0,4



## Deckenklemme für Profil 20 mm weiß



Ceiling grid pinch clip for profile 20 mm white  
Clip para rejilla para perfil de 20 mm blanco  
Crochet plafond pour profil 20 mm blanc

			 mm			 kg	
1203501025			25			100	0,1



## Deckenklemme für Profil 20 / 40 mm verzinkt



Ceiling grid pinch clip for profile 20 / 40 mm zinc  
Clip para rejilla para perfil de 20 / 40 mm zincado  
Crochet plafond pour profil 20 / 40 mm zingué

		 mm	 mm			 kg	
2503600142		1,6	65			100	0,3



## Deckenspinne für Rasterdecken verzinkt

Suspended ceiling clip zinc  
Gancho araña para techo zincado  
Crochet "faux-plafond" zingué

		 mm				 kg	
2500301542*		1,5				100	0,2
2500301042**		1,5				100	0,2







\* für Profil 20 mm/ for profile 20 mm/ para perfil 20 mm/ pour profil 20 mm  
\*\* für Profil 40 mm/ for profile 40 mm/ para perfil 40 mm/ pour profil 40 mm

## Deckenspinne für Rasterdecken verzinkt

Suspended ceiling clip zinc  
 Gancho arana para techo zincado  
 Crochet "faux-plafond" zingué







		 mm	 mm				 kg
2500303042		1,0	30			100	0,2

für Profil 20 mm/ for profile 20 mm/ para perfil 20 mm/ pour profil 20 mm

## Rohrhaken für 25 mm Rohr verzinkt

Hook for 25 mm tube zinc  
 Gancho para 25 mm tubo zincado  
 Crochet pour 25 mm tube zingué







		 mm	 mm				 kg
2501750543		2,0	54			100	0,3

## Rohrhaken für 30 mm Rohr verzinkt

Hook for 30 mm tube zinc  
 Gancho para 30 mm tubo zincado  
 Crochet pour 30 mm tube zingué







		 mm	 mm				 kg
0038-0200060		2,0	60			100	0,3
0038-0200115		2,0	115			100	0,5

## Rohrhaken für 25 mm Rohr verzinkt

Hook for 25 mm tube zinc  
 Gancho para 25 mm tubo zincado  
 Crochet pour 25 mm tube zingué





		 mm	 mm				 kg
0061-0300080		3,0	80			50	0,8
0061-0300250		3,0	250			50	1,8
0061-0300400		3,0	400			50	2,7
0061-0300700		3,0	700			50	4,9
0061-0301000		3,0	1000			50	6,1

Wir biegen Lösungen

## Duschmantelringe vernickelt



**Ring clip** nickel-plated  
**Gancho anillo** niquelado  
**Clip anneau** nichelé

							
1231690510	25	2,5				100	0,4
1231690310	30	2,5				100	0,5
1231690410	35	2,5				50	0,6



## Doppelhaken verzinkt



**Double hook** zinc  
**Gancho doble** zincado  
**Crochet double** zingué

							
2500760543	2,0	60				50	0,3



## Doppelhaken verzinkt



**Double hook** zinc  
**Gancho doble** zincado  
**Crochet double** zingué

							
2500570502	3,0	100				50	1,1



## S-Haken verzinkt

**S-Hook** zinc  
**Gancho "S"** zincado  
**Crochet "S"** zingué

							
5309-020028Z	2,0	28				100	0,2









## S-Haken verzinkt

**S-Hook** zinc  
**Gancho "S"** zincado  
**Crochet "S"** zingué







		 mm	 mm				 kg
0795-030045A		3,0	45			50	0,5

## S-Haken vernickelt

**S-Hook** nickel-plated  
**Gancho "S"** níquelado  
**Crochet "S"** nickelé







		 mm	 mm				 kg
1253080325		3,0	25			100	0,1

## S-Haken verzinkt

**S-Hook** zinc  
**Gancho "S"** zincado  
**Crochet "S"** zingué







		 mm	 mm				 kg
1253080440		4,0	40			100	0,2

## S-Haken verzinkt



**S-Hook** zinc  
**Gancho "S"** zincado  
**Crochet "S"** zingué



		 mm	 mm				 kg
3001230110		4,8	70			30	0,7

## S-Haken

S-Hook  
Gancho "S"  
Crochet "S"



				
3001000543	2,0	68	verzinkt	100 0,3
3001000549*	2,0	68	RAL 9010	100 0,3

\* Artikel nur auf Anfrage erhältlich / only on request / uniquement sur demande / solamente a pedido



## S-Haken

S-Hook  
Gancho "S"  
Crochet "S"



				
3001180102	5,0	120	verzinkt	50 3,6
3001180124*	5,0	120	RAL 9010	50 3,6

\* Artikel nur auf Anfrage erhältlich / only on request / uniquement sur demande / solamente a pedido



## S-Haken

S-Hook  
Gancho "S"  
Crochet "S"



				
3001170102	5,0	124	verzinkt	50 3,6
3001170124*	5,0	124	RAL 9010	50 3,6

\* Artikel nur auf Anfrage erhältlich / only on request / uniquement sur demande / solamente a pedido



## S-Haken weiß

S-Hook white  
Gancho "S" blanco  
Crochet "S" blanc

				
2510060124	6,0	80		50 2,9
2510061024	6,0	100		50 3,3
2510061224	6,0	120		50 3,6





Artikel nur auf Anfrage erhältlich / only on request / uniquement sur demande / solamente a pedido



## Plakathaken

C-Hook  
Gancho "C"  
Crochet "C"







	 mm	 mm			 kg
2501370543	2,0	39	verzinkt	100	0,2
2501370549*	2,0	39	RAL 9010	100	0,2

\* Artikel nur auf Anfrage erhältlich / only on request / uniquement sur demande / solamente a pedido

## Plakathaken

C-Hook  
Gancho "C"  
Crochet "C"







	 mm	 mm			 kg
2501390543	2,0	39	verzinkt	100	0,2
2501390549*	2,0	39	RAL 9010	100	0,2

\* Artikel nur auf Anfrage erhältlich / only on request / uniquement sur demande / solamente a pedido

## Plakathaken verzinkt

C-Hook zinc  
Gancho "C" zincado  
Crochet "C" zingué







	 mm	 mm		 kg
2500490543	2,0	60	100	0,3

## Plakathaken verzinkt

C-Hook zinc  
Gancho "C" zincado  
Crochet "C" zingué







	 mm	 mm		 kg
2501570543	2,0	80	100	0,5

Wir biegen Lösungen

## Plakathaken verzinkt

**C-Hook** zinc  
**Gancho "C"** zincado  
**Crochet "C"** zingué

2500740502		 4,8	 90			 50	 3,1
------------	--	---	--	--	--	--	---



## Schienenabhängung aus Edelstahl

**Rail clip** made of stainless steel  
**Clip para rail** acero inoxidable  
**Pince clip** en acier inoxydable

4000670100						 100	 0,4
------------	--	--	--	--	--	---	---



1

2

3

4

5

6

7

8





9

10

## Warenring ohne Haken verzinkt

Merchandise ring without hook zinc  
Anillo rondondo sin gancho zincado  
Anneau sans crochet zingué







		 mm	 mm				
9933-030060A		3,0	60			50	1,0
9933-040090A		4,0	90			50	2,8
9933-040120A		4,0	120			50	3,7
9933-040150A		4,0	150			50	4,9

## Warenring mit Haken verzinkt

Merchandise ring with hook zinc  
Anillo rondondo con gancho zincado  
Anneau avec crouchet zingué







		 mm	 mm				
9932-040120A		4,0	120			50	5,0

## Warenring mit Haken verzinkt

Merchandise ring with hook zinc  
Anillo rondondo con gancho zincado  
Anneau avec crouchet zingué







		 mm	 mm				
2500710502		3,8	85			50	4,0

## Heftring mit Klickfunktion vernickelt

Fixing ring with click mechanism nickel-plated  
Anillo con cierre "click" niquelado  
Anneau avec "click" mécanisme nickélé





		 mm	 mm				
9931-030019		2,4	19			100	0,6
9931-030038		3,0	38			100	0,7
9931-030051		3,3	51			100	0,8

Wir biegen Lösungen

## Lampen-Abhängehaken verzinkt



Light fitting suspension hook zinc  
Gancho colgante para lámpara zincado  
Crochet pour suspension de lampe zingué

		 mm	 mm			 kg
2503061042		3,4	100			1,8



## Lampen-Abhängehaken verzinkt



Light fitting suspension hook zinc  
Gancho colgante para lámpara zincado  
Crochet pour suspension de lampe zingué

		 mm	 mm			 kg
2503070142		4,0	190			3,9



## Überwachungsspiegel aus PVC, mit Halterung

PVC security mirror with bracket  
Espejo de seguridad de PVC con soporte  
Miroir de contrôle PVC avec crochet

		 mm				 kg
1203290100		450				140,0
1203310100		600				260,0





Artikel nur auf Anfrage erhältlich / only on request / uniquement sur demande / solamente a pedido

## Flauschband 5 Meter Rolle

**Frieze band** 5 meters roll  
**Cinta de cenefa** rollo de 5 m  
**Ruban-velours** rouleau à 5 mètres





13307301001										 1	 6,4
-------------	--	--	--	--	--	--	--	--	--	---	---

## Klettband 5 Meter Rolle

**Hook-and-loop tape** 5 meters roll  
**el velcro** rollo de 5 m  
**Ruban-crochets** rouleau à 5 mètres





13307001001										 1	 6,9
-------------	--	--	--	--	--	--	--	--	--	---	---

## Flauschpunkte 5 Meter Rolle

**Frieze sticker** 5 meters roll  
**Rollo adhesivo** de 5 m  
**Brodeurs de ruban-velours** rouleau à 5 mètres





13307401001										 1	 6,0
-------------	--	--	--	--	--	--	--	--	--	---	---

## Klettunkte 5 Meter Rolle

**Hook-and-loop sticker** 5 meters roll  
**Rollo adhesivo** de 5 m  
**Brodeurs de ruban-crochets** rouleau à 5 mètres



13307101001										 1	 6,0
-------------	--	--	--	--	--	--	--	--	--	---	---

## Displayklammer klarsicht

Clear display clip  
Pinza expositora transparente  
Pinze display transparente

	mm					
1299350300	120				50	3,0



## Klammer vernickelt

Pegs nickel-plated  
Pinzas niquelado  
Pinces nichelé

	mm					
1299310102	110				25	2,3



## Klammerbügel vernickelt

Peg hanger nickel-plated  
Perchas con pinzas niquelado  
Cintres nichelé

	mm					
6024992610	120				50	4,8
6024992620	200				50	5,8
6024992630	300				50	6,8
6024992640	400				50	7,8



## Klammer

Pegs  
Pinzas  
Pinces

	mm					
2499160100	50				100	1,1





## Klammer mit Haken

Pegs  
Pinzas  
Pinces



		↓ mm				📦	⚖️
2499310102		100				25	1,7

## Klammerbügel

Peg hanger  
Perchas con pinzas  
Cintres



		↔ mm				📦	⚖️
2499260102		120				50	4,4
2499260302		300				50	6,1
2499260502		400				50	7,0

## Spezialklammern in schwarz und weiß

Special peg in black and white colour  
Pinzas especiales en negro y blanco  
Pince spéciale en couleur noir et blanc



		↓ mm		📦	📦	⚖️
1267100100		50		RAL 9001	100	0,3
1267100200		50		RAL 9005	100	0,3
1267200100		110		RAL 9001	25	1,7
1267200200		110		RAL 9005	25	1,7

## Knotenkette verzinkt

Knotted link chain, 30 méters roll zinc  
Cadena acero, rollo 30 m zincado  
Chaîne acier, rouleau à 30 mètres zingué



		⌀ mm	T N			📦	⚖️
1200010030		1,0	ca. 7			1	72,0
1200011530		1,2	ca. 12			1	80,0
1200013030		1,6	ca. 22			1	88,0





## Quick-Clip aus Edelstahl, mit Haken und Sauger

**Quick-Clip** made of stainless steel, with hook and suction cup

**Quick-Clip** acero inoxidable, con gancho y ventosa

**Quick-Clip** en acier inoxydable, avec crochet et seueur



2503532500							 25	 1,5
------------	--	--	--	--	--	--	--	---





## Regalstopper für glatte Schienen aus Edelstahl

**Shelf clip for plain rail** made of stainless steel

**Topes de estanteria para rail liso** de acero inoxidable

**Clip glissière** en acier inoxydable



		 mm	 mm				 50	 0,3
2503890101		18	40					



## Regalstopper für Schienen-Profil 40 mm aus Edelstahl

**Shelf clip for rail profile 40 mm** made of stainless steel

**Topes de estanteria para perfil de 40 mm** de acero inoxidable

**Clip rail pour profil 40 mm** en acier inoxydable







			 mm				 50	 0,3
2503650101			57					
2503650601			57				50	0,3

## Preisschildständer, beweglich aus Edelstahl

Price card holder, flexible made of stainless steel

Portaprecios, movable de acero inoxidable

Support-prix, mobile en acier inoxydable

						
2509501000	2,0	100	95		25	6,2
2509501500	2,0	150	95		25	6,5
2509502000	2,0	200	95		25	6,8







## Preisschildständer, Höhen verstellbar aus Edelstahl

Price card holder, adjustable in height made of stainless steel

Portaprecios, ajustable de acero inoxidable

Support-prix, réglable en hauteur en acier inoxydable

						
2503330101	5,0	50	95		25	6,1
2503330301	5,0	100	95		25	6,7
2503330501	5,0	150	95		25	7,4
2503330701	5,0	200	95		25	8,1







## Preisschildständer, Höhen verstellbar aus Edelstahl

Price card holder, adjustable in height made of stainless steel

Portaprecios, ajustable de acero inoxidable

Support-prix, réglable en hauteur en acier inoxydable

						
2503250100	3,5	50	75		25	3,7
2503250300	3,5	100	75		25	4,1
2503250500	3,5	150	75		25	4,5
2503250700	3,5	200	75		25	4,7







## Preisschildständer, Höhen verstellbar aus Edelstahl

Price card holder, adjustable in height made of stainless steel

Portaprecios, ajustable de acero inoxidable

Support-prix, réglable en hauteur en acier inoxydable

						
2503950300	2,0	100	95		25	5,2
2503950500	2,0	150	95		25	5,4
2503950700	2,0	200	95		25	5,6



Artikel nur auf Anfrage erhältlich / only on request / uniquement sur demande / solamente a pedido

## Preisschildhalter aus Edelstahl, liegend

**Price card holder** made of stainless steel, horizontal

**Portaprecios** de acero inoxidable, horizontal

**Support-prix** en acier inoxydable, couché



2503260100								50	1,1
------------	--	--	--	--	--	--	--	----	-----

## Preisschildhalter aus Edelstahl, für Pralinenbleche

**Price card holder** made of stainless steel, for chocolate trays

**Portaprecios** de acero inoxidable, para tabla chocolate

**Support-prix** en acier inoxydable, pour plaques à présenter du chocolat



2503830100								50	0,9
------------	--	--	--	--	--	--	--	----	-----

## Preisschildhalter aus Edelstahl, für Glasböden und Backbleche

**Price card holder** made of stainless steel, for glass shelves and baking trays

**Portaprecios** de acero inoxidable, para placa de vidrio y bandeja de horno

**Support-prix** en acier inoxydable, pour étagères verrées et plaques de four



2503720300		1-5						50	0,9
2503720100		6-11						50	1,0

## Preisschildhalter aus Edelstahl, für Ablage und Regale

**Price card holder** made of stainless steel, for shelves

**Portaprecios** acero inoxidable, para ficheros y estanterías

**Support-prix** en acier inoxydable, pour étagères





2503810100		12-15						50	0,9
2503810300		16-19						50	1,1
2503810500		20-25						50	1,2

## Preisschildhalter aus Edelstahl, für Tafel

Price card holder made of stainless steel, for plates

Portaprecios acero inoxidable, para tabla

Support-prix en acier inoxydable, pour paques

						
2503850200		5-7			50	0,6
2503850100		12-15			50	0,9
2503850300		16-19			50	1,1
2503850500		20-25			50	1,2





## Preisschildhalter aus Edelstahl, für Körbe

Price card holder made of stainless steel, for baskets

Portaprecios acero inoxidable, para cesta

Support-prix en acier inoxydable, pour corbeilles

						
2503730100		12-15			50	1,0
2503730300		16-19			50	1,1
2503730500		20-25			50	1,2





## Preisschildhalter aus Edelstahl, für Konfektauslagen

Price card holder made of stainless steel, for displayed sweetmeats

Portaprecios acero inoxidable, para escaparate

Support-prix en acier inoxydable, pour présentation de chocolats

						
2503870100					50	0,9







## Preisspieß aus Edelstahl

Price needle made of stainless steel

Portaprecios pincho de acero inoxidable

Pric-prix en acier inoxydable

						
2503960500	2,5	150			50	0,9
2503960800	2,5	250			50	1,2
2503961000	2,5	350			50	1,5



## Preisspieß aus Edelstahl

**Price needle** made of stainless steel  
**Portaprecios pincho** de acero inoxidable  
**Pric-prix en** acier inoxydable



	⌀ mm	l mm				kg
2503740300	3,5	200			25	0,2
2503740500	3,5	300			25	0,2
2503740700	3,5	400			25	0,3

## Preisschildhalter schwarz

**Price card holder** black  
**Portaprecios** negro  
**Support prix** noir



	⌀ mm	l mm				kg
2503750200	4,0	200			25	7,0
2503750400	4,0	400			25	14,0
2503750600	4,0	600			25	21,0

Artikel nur auf Anfrage erhältlich / only on request / uniquement sur demande / solamente a pedido

## Haftscheiben selbstklebend

**Adhesive disc** self-adhesive  
**Disco** autoadhesivo  
**Disque adhésif** autoadhésif



	⌀ mm					kg
2500290500	38				50	0,5

## Haftscheiben selbstklebend aus Metall / ohne Magnet



**Adhesive disc** self-adhesive, made of metal / without magnet  
**Disco** autoadhesivo, de metal / sin imán  
**Disque adhésif** autoadhésif, en métal / sans aimant



	⌀ mm					kg
2500520520	34				50	1,1

## Deckenmagnete





Ceiling magnets  
Imán techo  
Aimants plafond

						
1201410500		ca. 3,0			50	1,3



## Deckenmagnete



Ceiling magnets  
Imán techo  
Aimants plafond

						
1201410100		ca. 5,0		vernickelt	50	0,8
1201410200		ca. 5,0		RAL 9010	50	0,8



## Deckenmagnet weiß



Ceiling magnets white  
Imán techo blanco  
Aimant plafond blanc

						
1201420055		ca. 5,5			20	3,0



## Deckenmagnet weiß

Ceiling magnet white  
Imán techo blanco  
Aimant plafond blanc

						
1201420100		ca. 11,0			20	5,3







## Rechteck-Leistenmagnete weiß

**Rectangular magnet** white  
**Imán rectangular** blanco  
**Aimant rectangulaire** blanc





							
1201431030			ca. 30,0			40	13,0

## Rechteck-Leistenmagnet weiß

**Rectangular magnet** white  
**Imán rectangular** blanco  
**Aimant rectangulaire** blanc







							
25014401001			ca. 7,0-10,0			50	5,3
25014404001*			ca. 40,0			50	5,3

\* speziell für Odenwalddecken / especially for suspended ceilings  
 \* para rejilla en especial / pour „faux-plafond“ en particulier

## Rundmagnet weiß

**Round magnet** white  
**Imán redondo** blanco  
**Aimant rond** blanc



						
1201440220	20	ca. 1,5-2,0			50	1,3
1201440320	25	ca. 2,5-3,0			50	3,4
1201440720	36	ca. 7,0			50	4,5
1201441320	40	ca. 13,0			50	5,8
1201441820	47	ca. 18,0			50	10,7



# HOHAGE

Wir biegen Lösungen

**C. Hohage GmbH & Co. KG**

Rahmedestrasse 406 - 408

D-58762 Altena

☎ +49 2352 5430

☎ +49 2352 54310

@ info@hohage.de

www.hohage.de